

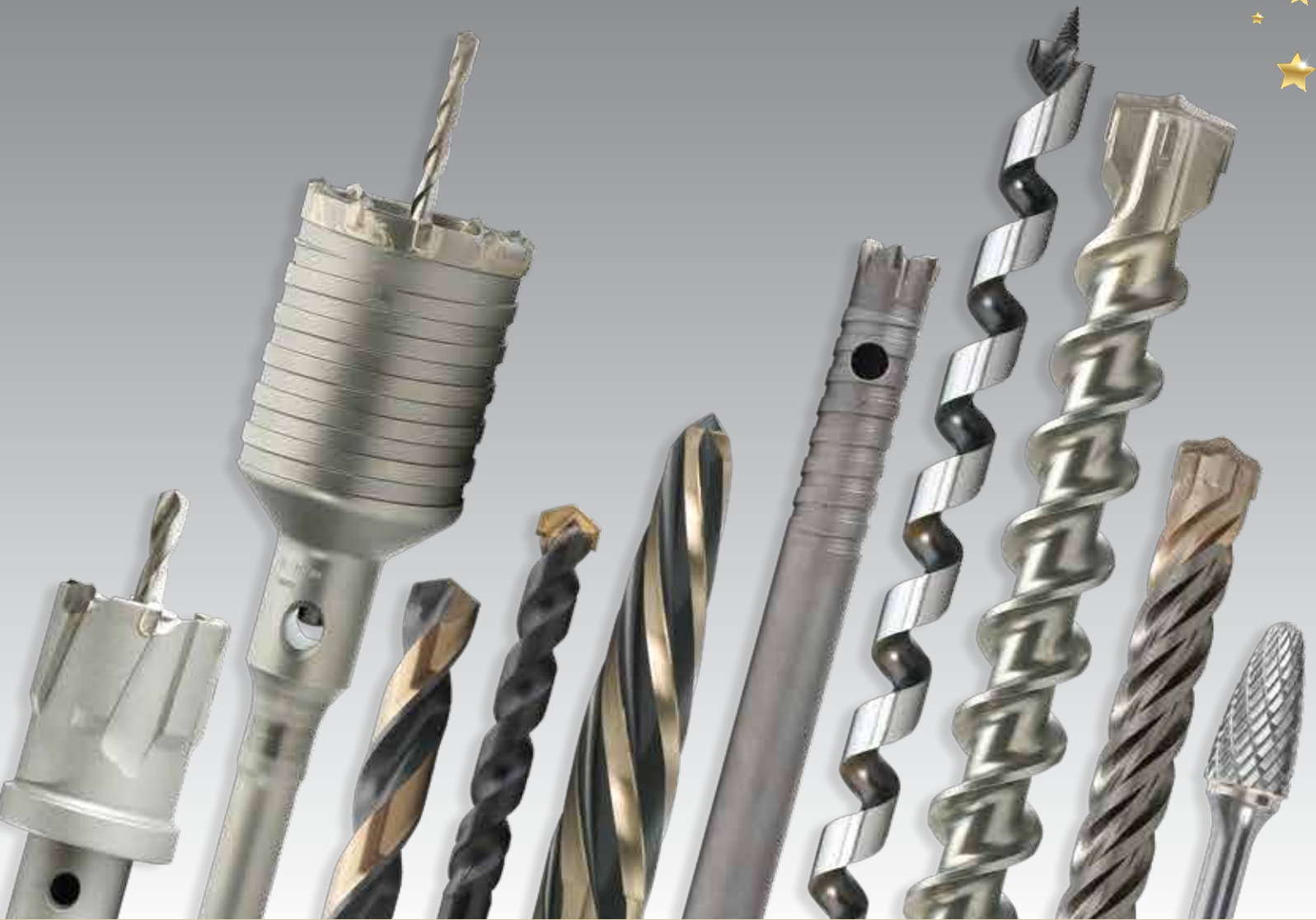

**ITM**



**“ANYTHING THAT MAKES A HOLE”<sup>®</sup>**



**CONSTRUCTION DRILLING AND CUTTING SOLUTIONS**

**WWW.ITMTOOLS.COM | (800) 247-5696 | SALES@ITMTOOLS.COM**



# 100% LAB TESTED

## FAST DELIVERY

4000 items and 99% of all orders are shipped the same day if received before 3 P.M. Eastern Time.

## EASY ORDERING

Order toll free, by fax, or email, either by part number or description. Our staff will quickly help you decide which product best fits your application. Order what you need, there is never a minimum order.

## COMPLETE SATISFACTION

Simple: all of your purchases must satisfy you completely, or we will issue you a refund, exchange, or credit.

**ITM** catalogs are always made with YOU in mind! We hope you find our catalog easy to use and our staff a valuable resource for your business.

Thank you for your business and patronage.

Call us. We are here to make your life a little bit easier.

Sincerely yours,

**Berardo Paradiso**  
President - ITM Corp.

**Alberic Paradiso**

**Bryan Markell**

**Gwen Rodgers**

**Jonathon Sessions**

**Desi Persaud**

**Annette Kempadoo**

**Marilyn Rodriguez**

**Pam Sullivan**

**Chun Keat**



**BLACK Oxide**

- p.10 Two Tone Jobbers HSS 118° Point
- p.10 Bright Finish Jobbers HSS 118° Point
- p.11 Black Oxide Jobbers HSS 118° Point
- p.11 Black Oxide Wire Gauge HSS 118° Point
- p.12 Black Oxide Jobbers HSS 135° Split Point
- p.12 Black Oxide Wire Gauge HSS 135° Split Point
- p.13 Black Oxide Letter HSS 135° Split Point
- p.13 Black Oxide Metric HSS 118° Point
- p.14 Black Oxide Stub Length HSS 135° Split Point
- p.15 Black Oxide Silver & Deming HSS 118° Point



**Black & Gold**

- p.17 Black & Gold Jobbers HSS 135° Split Point
- p.17 Black & Gold Wire Gauge HSS 135° Split Point
- p.18 Black & Gold Mechanics Length HSS 135° Split Point
- p.19 Black & Gold Letter Size HSS 135° Split Point
- p.19 Black & Gold Silver & Deming HSS 118° Split Point



**Cobalt**

- p.20 Cobalt Jobbers 135° Split Point
- p.20 Cobalt Wire Gauge 135° Split Point
- p.21 Cobalt Stub Length 135° Split Point
- p.21 Cobalt Silver & Deming 118° Split Point



- p.22 Titanium (TiN) Jobbers HSS 135° Split Point
- p.22 Spotweld Double End Drills
- p.22 Double End Drills 135° Split Point
- p.23 Aircraft HSS 135° Split Point (6", 12" & 18" Long)



**Made In**



- p.24 MRO Black & Gold Jobbers 135° Split Point
- p.25 MRO Black & Gold Wire Gauge 135° Split Point
- p.26 Parabolic Jobbers 135° Split Point
- p.26 Cobalt Jobbers 135° Split Point



- p.27 Bullet Case Drill Bit Sets



- p.28+ Metal Drill Bit Sets / Dispenser



Tap & Drill Sets

Counter Sinks

Screw Extractors

Taps, Carbon Steel

Taps, HSS

Taps, NPT

Hand Tap Wrenches

Combo Drill Taps

Spiral Point (Gun) Taps

Wire Brushes

Rednut Wire Cup Adapter

Burs - Solid Carbide

Step Drills HSS

Reamers

Annular Cutters HSS

T.C.T. Annular Cutters

T.C.T. Hole Cutters

Roto Plate Cutters

Hole Saws - Bi-Metal

Hole Saws - Carbide Tipped

Hole Saws - Carbide Grit

Pilot Drills and Accessories

Arbors

p.30

p.32

p.32

p.34

p.35

p.36

p.36

p.37

p.37

p.38

p.38

p.40

p.42

p.44+

p.48

p.49

p.50

p.52

p.53

p.54

p.55

p.56

p.57





p.59 Reciprocating Blades - Bi-Metal



p.60 Reciprocating Blades - Bi-Metal Heavy Metal, Heavy Duty & Demolition



p.62 Reciprocating Blades - Retail Packs



p.64 Jig Saw Blades - Bi-Metal



p.65 Hack-Saw Blades - Bi-Metal



p.65 Band-Saw Blades - Bi-Metal



p.66 Metal Display Racks



p.67 Electrician's Flex Bit (Stretch Bit)



p.67 Circular Saw Blades - Wood



p.68 Bell Hanger Drills (Fish Hole Drills) HSS & Carbide Tipped



p.69 Long Boy Drills HSS (12" & 18")



p.69 Brad Point Wood Drills



p.70 Spade Drills



p.71 Self Feed (Multispur) Wood Drills



p.71 Extensions (For Ship Augers / Multispur)



p.72 Power Pole Auger Drills



p.73 Ship Auger Wood Drills (8" & 18" Long)



p.74 Single Spur / Double Spur Wood Drills



p.75 Oscillating Blades / Drywall Cutter



p.76 V Groove Tile Bit



p.76 Diamond Tile Bit



p.76 Glass Drills



p.77 Multi Purpose Drills - Carbide



p.77 Hard Steel Drills - Cast Iron / Safes



Masonry Drills - Black Oxide - Slow Spiral

p.78



Roto Percussion Masonry Drills

p.79



SDS-Plus Redline

p.81



SDS-Plus Bohr Hammer

p.82+



SDS-Plus X-Cutter

p.86



SDS-Plus Evolution

p.87



SDS+ Stop (For Drop In Anchors)

p.88



SDS-Plus Adapters

p.88



Tap-Con Drills

p.89



SDS-HEX Hammer Drills

p.89



Concrete Screw Sleeve

p.89



SDS-Max Hammer Drills

p.91



Extension Systems / Adapters

p.92



Core Bits - SDS-Plus Exacto

p.93



Core Bits - SDS-Max Taper Shanks

p.94



Core Bits - SDS-Max 1 Piece

p.95



Tunnel Bore Drills

p.96



Ratio Drilling System

p.97



Spline Hammer Drills

p.98



Duster Hammer Bits (HEPA Vacuums)

p.100



Dust Pro Cups (HEPA Vacuums)

p.101





p.102 Rebar Cutters



p.104 Chisels



p.106 Composite Cutters



p.107 Diamond Core Bits - SDS-Plus Superdry



p.108 Diamond Core Bits (Wet Drilling)



p.110 Diamond Core Bits (Dry Drilling)



p.111+ Diamond Cutting Wheels



p.114+ Screwdriver Insert Bits



p.120 Bit Holders



p.122 Sockets (Magnetic Impact) & Drivers



p.123 Nut Setters - Magnetic / Impact Protection



p.124 Insert Bit Sets & MEGAPRO Screwdriver



p.126 Cable Ties



p.127 Plastic Anchor Kits



p.127 Metal Anchors



p.128 Utility Knives and Accessories

### Terms Of Sale

**Terms:** 2% 10 Days, Net 30 Days. All credit cards welcome.

**Credit:** Open account privileges are extended to any firm that is satisfactorily rated. New accounts should submit at least 3 commercial references including all contact information and their tax resale number.

**Quantities:** Although there is no minimum purchase order, we reserve the right to adjust any order to the minimum packaged quantities indicated in catalog.

**Freight:** Prepaid for NET invoices equaling \$600 or more.

**EFFECTIVE August, 2018.**



expertise

because drilling solutions



can be out of the ordinary







# HSS TOOL DATA

## Suggested Drill Bits To Be Used For Various Types Of Materials:

MATERIAL	DRILL STYLE	ANGLE POINT	PRESSURE TO APPLY	COOLANT OR LUBRICANT
CARBON STEEL DUCTILE STEEL BRASS BRONZE	GENERAL PURPOSE DRILLS	118° POINT	MEDIUM TO HEAVY	OIL or WATER SOLUTION
CARBON STEEL ALUMINUM AUSTENITIC STAINLESS STEEL	HEAVY DUTY AND TITANIUM	135° SPLIT POINT	MEDIUM TO HEAVY	OIL or ACTIVATED SOLUTION
STAINLESS STEEL SERIES C CAST IRON	COBALT DRILLS	135° SPLIT POINT	MEDIUM TO HEAVY	OIL or ACTIVATED SOLUTION
HARD STEEL HEAT TREATED ALLOYS	HARD BODY CARBIDE TIPPED AND COBALT	130° & 135° SPLIT POINT	HEAVY	OIL or ACTIVATED SOLUTION

## Chemical Analysis Of The Three Primary High Speed Steels Used To Manufacture HSS Drill Bits:

TYPE	CHEMICAL COMPOSITION						ROCKWELL C HARDNESS	TERM
	CARBON	TUNGSTEN	MOLYBDENUM	CHROMIUM	VANADIUM	COBALT		
M2	0.85	6.00	5.00	4.00	1.90	-	63-65	HSS
M35	1.10	1.50	9.50	1.15	1.15	5.00	65-67	COBALT
M42	1.10	1.50	9.50	1.15	1.15	8.00	65-67	SUPER COBALT

**M2** "HSS" is the standard material used for all **ITM** drill bits. M2 has good red-hardness and retains its cutting edge longer than other general purpose high speed steels because of its increased quantity of tungsten (dull red heat up to 1000° F without loss of hardness or rapid dulling of cutting edge). M2 is generally favored for high production machine work.

**M35** M35 is the standard cobalt material used for most **ITM** cobalt drill bits. M35 has excellent resistance to abrasion and very good red-hardness for working difficult materials.

**M42** M42 "Super Cobalt" is American made premium cobalt material used for higher performance **ITM** cobalt drill bits. M42 has the best resistance to abrasion and red-hardness.

### COBALT DRILLS

Made of the finest Cobalt steel obtainable and furnished with a 135° split point, these drills are designed for use in machining hard, tough materials beyond the normal cutting capabilities of regular high speed steel tools. These include work-hardening grades of stainless steels, titanium, high temperature alloys, and many other heat treated materials. In addition, due to their resistant properties, they can also be used at higher speeds to drill abrasive plastics, cast iron, and other types of difficult to machine work materials.



**Always Use Protection When Drilling.**

**Always Use High RPM For Smaller Diameters and Lower RPM For Larger Diameters.**

# HSS TOOL DATA

## Understanding High Speed Steel Drill Bits:

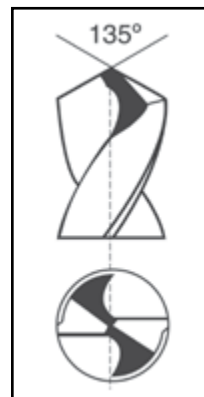
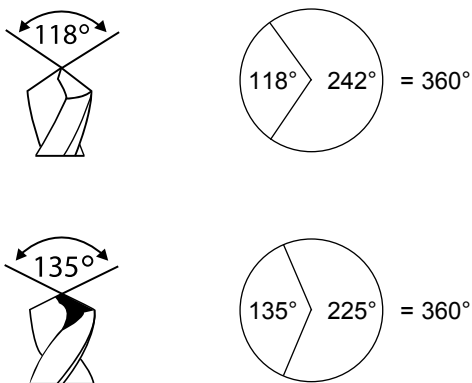

### Split Point

An extra cutting angle on the 2 cutting edges of a drill bit.

Split Point is designated here in black.

Split Pointing is almost always reserved for 135° HSS drill bits.

118° drill bits have a sharp point and are common on standard / general purpose drill bits where light duty work is needed. Because of this sharp point, 118° drill bits will tend to “walk” or spin like a top on flat surfaces. This is why a centering drill or center punch is normally used to start off holes. If the operator has very steady hands, then the 118° drill bit can be used without center punching.

135° drill bits have a flatter point which gives the drill bit more cutting surface area. When more surface area cuts the steel, drilling is faster.



## Understanding Nomenclature Vis-a-vis Size:

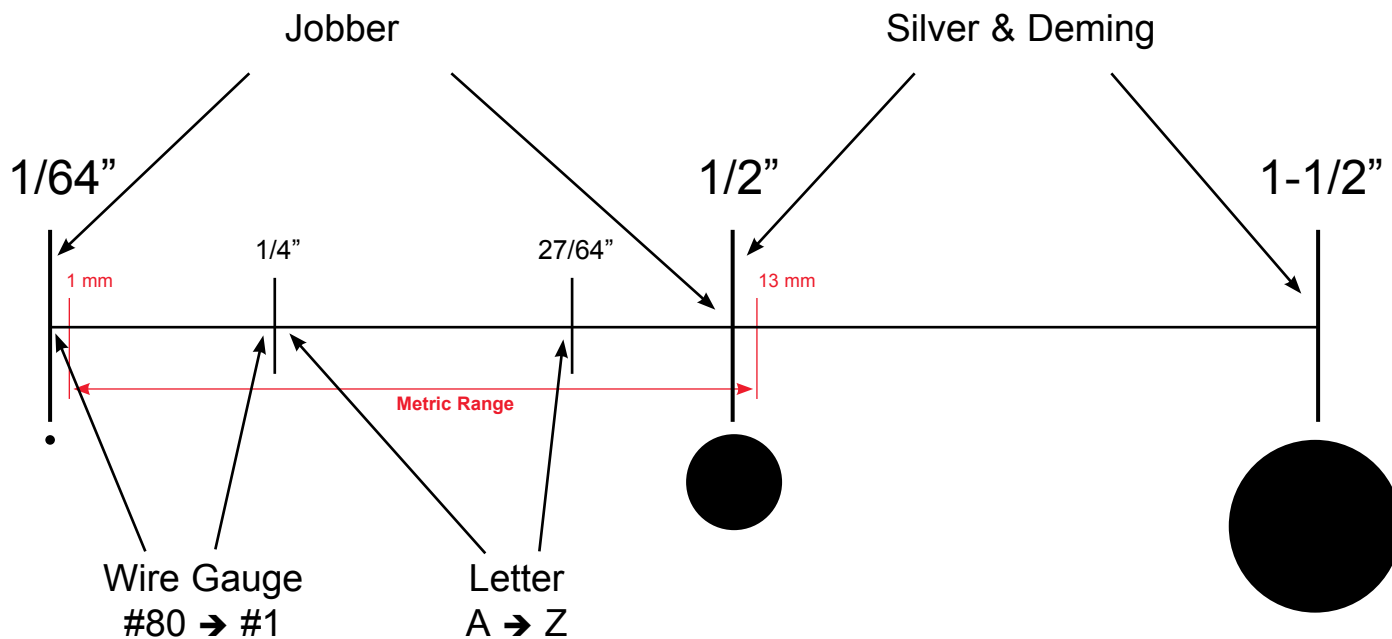

Chart Not To Scale.



**Jobber Drills - General Purpose - TWO TONE FINISH M2 HSS**

- ◆ Jobber Length
- ◆ 118° Point
- ◆ General Purpose
- ◆ Roll Forged
- ◆ Straight Shank
- ◆ Two Tone Finish
- ◆ M2 HSS

- ➔ Cast Iron
- ➔ Steel
- ➔ Steel Forging
- ➔ Light to Medium Materials

Part #	Size	Dec.	OAL	Flute	Qty.	List	Part #	Size	Dec.	OAL	Flute	Qty.	List
200HS0464	1/16"	.0625	1-7/8"	7/8"	12	\$0.92	200HS1964	19/64"	.2969	4-3/8"	3-1/16"	12	\$3.29
200HS0564	5/64"	.0781	2"	1"	12	\$0.92	200HS2064	5/16"	.3125	4-1/2"	3-3/16"	12	\$3.40
200HS0664	3/32"	.0938	2-1/4"	1-1/4"	12	\$0.92	200HS2164	21/64"	.3281	4-5/8"	3-5/16"	6	\$3.83
200HS0764	7/64"	.1094	2-5/8"	1-1/2"	12	\$0.92	200HS2264	11/32"	.3438	4-3/4"	3-7/16"	6	\$4.36
200HS0864	1/8"	.1250	2-3/4"	1-5/8"	12	\$0.92	200HS2364	23/64"	.3594	4-7/8"	3-1/2"	6	\$4.98
200HS0964	9/64"	.1406	2-7/8"	1-3/4"	12	\$1.02	200HS2464	3/8"	.3750	5"	3-5/8"	6	\$5.64
200HS1064	5/32"	.1562	3-1/8"	2"	12	\$1.06	200HS2564	25/64"	.3906	5-1/8"	3-3/4"	6	\$6.11
200HS1164	11/64"	.1719	3-1/4"	2-1/8"	12	\$1.16	200HS2664	13/32"	.4062	5-1/4"	3-1/8"	6	\$6.28
200HS1264	3/16"	.1875	3-1/2"	2-5/16"	12	\$1.29	200HS2764	27/64"	.4219	5-3/8"	3-15/16"	6	\$6.96
200HS1364	13/64"	.2031	3-5/8"	2-7/16"	12	\$1.49	200HS2864	7/16"	.4375	5-1/2"	4-1/16"	6	\$7.45
200HS1464	7/32"	.2188	3-3/4"	2-1/2"	12	\$1.66	200HS2964	29/64"	.4531	5-5/8"	4-3/16"	6	\$8.79
200HS1564	15/64"	.2344	3-7/8"	2-5/8"	12	\$1.91	200HS3064	15/32"	.4688	5-3/4"	4-5/16"	6	\$8.93
200HS1664	1/4"	.2500	4"	2-3/4"	12	\$2.15	200HS3164	31/64"	.4844	5-7/8"	4-3/8"	6	\$9.49
200HS1764	17/64"	.2656	4-1/8"	2-7/8"	12	\$2.68	200HS3264	1/2"	.5000	6"	4-1/2"	6	\$10.72
200HS1864	9/32"	.2812	4-1/4"	2-15/16"	12	\$3.06							



**Jobber Drills - General Purpose - BRIGHT FINISH M2 HSS**

- ◆ Jobber Length
- ◆ 118° Point
- ◆ General Purpose
- ◆ Ground Flute
- ◆ Straight Shank
- ◆ Bright Finish
- ◆ M2 HSS

- ➔ Cast Iron
- ➔ Steel
- ➔ Steel Forging
- ➔ Light to Medium Materials

Part #	Size	Dec.	OAL	Flute	Qty.	List	Part #	Size	Dec.	OAL	Flute	Qty.	List
250US0164	1/64"	.0156	3/4"	3/16"	12	\$1.45	250US1764	17/64"	.2656	4-1/8"	2-7/8"	12	\$3.81
250US0264	1/32"	.0312	1-3/8"	1/2"	12	\$1.45	250US1864	9/32"	.2812	4-1/4"	2-15/16"	12	\$4.10
250US0364	3/64"	.0469	1-3/4"	3/4"	12	\$1.45	250US1964	19/64"	.2969	4-3/8"	3-1/16"	12	\$4.62
250US0464	1/16"	.0625	1-7/8"	7/8"	12	\$0.93	250US2064	5/16"	.3125	4-1/2"	3-3/16"	12	\$5.67
250US0564	5/64"	.0781	2"	1"	12	\$0.93	250US2164	21/64"	.3281	4-5/8"	3-5/16"	6	\$5.96
250US0664	3/32"	.0938	2-1/4"	1-1/4"	12	\$0.93	250US2264	11/32"	.3438	4-3/4"	3-7/16"	6	\$6.48
250US0764	7/64"	.1094	2-5/8"	1-1/2"	12	\$0.93	250US2364	23/64"	.3594	4-7/8"	3-1/2"	6	\$7.44
250US0864	1/8"	.1250	2-3/4"	1-5/8"	12	\$1.00	250US2464	3/8"	.3750	5"	3-5/8"	6	\$7.96
250US0964	9/64"	.1406	2-7/8"	1-3/4"	12	\$1.14	250US2564	25/64"	.3906	5-1/8"	3-3/4"	6	\$9.82
250US1064	5/32"	.1562	3-1/8"	2"	12	\$1.38	250US2664	13/32"	.4062	5-1/4"	3-1/8"	6	\$10.49
250US1164	11/64"	.1719	3-1/4"	2-1/8"	12	\$1.67	250US2764	27/64"	.4219	5-3/8"	3-15/16"	6	\$11.15
250US1264	3/16"	.1875	3-1/2"	2-5/16"	12	\$1.91	250US2864	7/16"	.4375	5-1/2"	4-1/16"	6	\$11.58
250US1364	13/64"	.2031	3-5/8"	2-7/16"	12	\$2.15	250US2964	29/64"	.4531	5-5/8"	4-3/16"	6	\$12.11
250US1464	7/32"	.2188	3-3/4"	2-1/2"	12	\$2.34	250US3064	15/32"	.4688	5-3/4"	4-5/16"	6	\$14.16
250US1564	15/64"	.2344	3-7/8"	2-5/8"	12	\$2.81	250US3164	31/64"	.4844	5-7/8"	4-3/8"	6	\$14.82
250US1664	1/4"	.2500	4"	2-3/4"	12	\$3.24	250US3264	1/2"	.5000	6"	4-1/2"	6	\$16.21



### Jobber Drills - General Purpose - BLACK FINISH M2 HSS

Part #	Size	Dec.	OAL	Flute	Qty.	List	Part #	Size	Dec.	OAL	Flute	Qty.	List
200BF0464	1/16"	.0625	1-7/8"	7/8"	12	\$0.75	200BF1964	19/64"	.2969	4-3/8"	3-1/16"	12	\$2.36
200BF0564	5/64"	.0781	2"	1"	12	\$0.75	200BF2064	5/16"	.3125	4-1/2"	3-3/16"	12	\$2.41
200BF0664	3/32"	.0938	2-1/4"	1-1/4"	12	\$0.75	200BF2164	21/64"	.3281	4-5/8"	3-5/16"	6	\$2.73
200BF0764	7/64"	.1094	2-5/8"	1-1/2"	12	\$0.75	200BF2264	11/32"	.3438	4-3/4"	3-7/16"	6	\$3.16
200BF0864	1/8"	.1250	2-3/4"	1-5/8"	12	\$0.75	200BF2364	23/64"	.3594	4-7/8"	3-1/2"	6	\$3.56
200BF0964	9/64"	.1406	2-7/8"	1-3/4"	12	\$0.75	200BF2464	3/8"	.3750	5"	3-5/8"	6	\$3.66
200BF1064	5/32"	.1562	3-1/8"	2"	12	\$0.78	200BF2564	25/64"	.3906	5-1/8"	3-3/4"	6	\$3.96
200BF1164	11/64"	.1719	3-1/4"	2-1/8"	12	\$0.83	200BF2664	13/32"	.4062	5-1/4"	3-7/8"	6	\$4.07
200BF1264	3/16"	.1875	3-1/2"	2-5/16"	12	\$0.92	200BF2764	27/64"	.4219	5-3/8"	3-15/16"	6	\$4.51
200BF1364	13/64"	.2031	3-5/8"	2-7/16"	12	\$1.06	200BF2864	7/16"	.4375	5-1/2"	4-1/16"	6	\$4.93
200BF1464	7/32"	.2188	3-3/4"	2-1/2"	12	\$1.17	200BF2964	29/64"	.4531	5-5/8"	4-3/16"	6	\$5.87
200BF1564	15/64"	.2344	3-7/8"	2-5/8"	12	\$1.40	200BF3064	15/32"	.4688	5-3/4"	4-5/16"	6	\$6.02
200BF1664	1/4"	.2500	4"	2-3/4"	12	\$1.52	200BF3164	31/64"	.4844	5-7/8"	4-3/8"	6	\$6.43
200BF1764	17/64"	.2656	4-1/8"	2-7/8"	12	\$1.91	200BF3264	1/2"	.5000	6"	4-1/2"	6	\$6.59
200BF1864	9/32"	.2812	4-1/4"	2-15/16"	12	\$2.18							

- ◆ Jobber Length
- ◆ 118° Point
- ◆ General Purpose
- ◆ Roll Forged
- ◆ Straight Shank
- ◆ Black Oxide Finish
- ◆ M2 HSS

- Cast Iron
- Steel
- Steel Forging
- Light to Medium Materials

### Wire Gauge Drills - General Purpose - BLACK FINISH M2 HSS

Part #	Size	Dec.	OAL	Flute	Qty.	List	Part #	Size	Dec.	OAL	Flute	Qty.	List
203HS0001	1	.2280	3-7/8"	2-5/8"	12	\$1.63	203HS0031	31	.1200	2-3/4"	1-5/8"	12	\$0.94
203HS0002	2	.2210	3-7/8"	2-5/8"	12	\$1.63	203HS0032	32	.1160	2-3/4"	1-5/8"	12	\$0.94
203HS0003	3	.2130	3-3/4"	2-1/2"	12	\$1.77	203HS0033	33	.1130	2-5/8"	1-1/2"	12	\$0.94
203HS0004	4	.2090	3-3/4"	2-1/2"	12	\$1.77	203HS0034	34	.1110	2-5/8"	1-1/2"	12	\$0.94
203HS0005	5	.2055	3-3/4"	2-1/2"	12	\$1.77	203HS0035	35	.1100	2-5/8"	1-1/2"	12	\$0.94
203HS0006	6	.2040	3-3/4"	2-1/2"	12	\$1.77	203HS0036	36	.1065	2-1/2"	1-7/16"	12	\$0.94
203HS0007	7	.2010	3-5/8"	2-7/16"	12	\$1.77	203HS0037	37	.1040	2-1/2"	1-7/16"	12	\$0.94
203HS0008	8	.1990	3-5/8"	2-7/16"	12	\$1.77	203HS0038	38	.1015	2-1/2"	1-7/16"	12	\$0.94
203HS0009	9	.1960	3-5/8"	2-7/16"	12	\$1.77	203HS0039	39	.0995	2-3/8"	1-3/8"	12	\$0.94
203HS0010	10	.1935	3-5/8"	2-7/16"	12	\$1.77	203HS0040	40	.0980	2-3/8"	1-3/8"	12	\$0.94
203HS0011	11	.1910	3-1/2"	2-5/16"	12	\$1.68	203HS0041	41	.0960	2-3/8"	1-3/8"	12	\$0.94
203HS0012	12	.1890	3-1/2"	2-5/16"	12	\$1.68	203HS0042	42	.0935	2-1/4"	1-1/4"	12	\$0.94
203HS0013	13	.1850	3-1/2"	2-5/16"	12	\$1.68	203HS0043	43	.0890	2-1/4"	1-1/4"	12	\$0.94
203HS0014	14	.1820	3-3/8"	2-3/16"	12	\$1.68	203HS0044	44	.0860	2-1/8"	1-1/8"	12	\$0.94
203HS0015	15	.1800	3-3/8"	2-3/16"	12	\$1.68	203HS0045	45	.0820	2-1/8"	1-1/8"	12	\$0.94
203HS0016	16	.1770	3-3/8"	2-3/16"	12	\$1.68	203HS0046	46	.0810	2-1/8"	1-1/8"	12	\$0.94
203HS0017	17	.1730	3-3/8"	2-3/16"	12	\$1.68	203HS0047	47	.0785	2"	1"	12	\$0.94
203HS0018	18	.1695	3-1/4"	2-1/8"	12	\$1.68	203HS0048	48	.0760	2"	1"	12	\$0.94
203HS0019	19	.1660	3-1/4"	2-1/8"	12	\$1.68	203HS0049	49	.0730	2"	1"	12	\$0.94
203HS0020	20	.1610	3-1/4"	2-1/8"	12	\$1.50	203HS0050	50	.0700	2"	1"	12	\$0.94
203HS0021	21	.1590	3-1/4"	2-1/8"	12	\$1.50	203HS0051	51	.0670	2"	1"	12	\$0.94
203HS0022	22	.1570	3-1/8"	2"	12	\$1.57	203HS0052	52	.0635	1-7/8"	7/8"	12	\$0.94
203HS0023	23	.1540	3-1/8"	2"	12	\$1.57	203HS0053	53	.0595	1-7/8"	7/8"	12	\$0.94
203HS0024	24	.1520	3-1/8"	2"	12	\$1.12	203HS0054	54	.0550	1-7/8"	7/8"	12	\$0.94
203HS0025	25	.1495	3"	1-7/8"	12	\$1.12	203HS0055	55	.0520	1-7/8"	7/8"	12	\$0.94
203HS0026	26	.1470	3"	1-7/8"	12	\$1.12	203HS0056	56	.0465	1-3/4"	3/4"	12	\$0.94
203HS0027	27	.1440	3"	1-7/8"	12	\$1.12	203HS0057	57	.0430	1-3/4"	3/4"	12	\$0.94
203HS0028	28	.1405	2-7/8"	1-3/4"	12	\$1.12	203HS0058	58	.0420	1-5/8"	11/16"	12	\$0.94
203HS0029	29	.1360	2-7/8"	1-3/4"	12	\$0.94	203HS0059	59	.0410	1-5/8"	11/16"	12	\$0.94
203HS0030	30	.1285	2-3/4"	1-5/8"	12	\$0.94	203HS0060	60	.0400	1-5/8"	11/16"	12	\$0.94

- ◆ Wire Gauge
- ◆ 118° Point
- ◆ General Purpose
- ◆ Roll Forged
- ◆ Straight Shank
- ◆ Black Oxide Finish
- ◆ M2 HSS

- Cast Iron
- Steel
- Steel Forging
- Light to Medium Materials



AVAILABLE:  
SIZES 61 → 80  
List \$1.80



Jobber Drills - HEAVY DUTY - BLACK OXIDE FINISH M2 HSS

- ◆ Jobber Length
◆ 135° Split Point
◆ Ground Flute
◆ Straight Shank
◆ Heavy Duty Web
◆ Black Oxide Finish
◆ M2 HSS

- ➔ Cast Iron
➔ Steel
➔ Steel Forging
➔ Light Gauge Stainless Steel

Table with 14 columns: Part #, Size, Dec., OAL, Flute, Qty., List, Part #, Size, Dec., OAL, Flute, Qty., List. Contains 24 rows of drill specifications.



Wire Gauge Drills - HEAVY DUTY - BLACK OXIDE FINISH M2 HSS

- ◆ Wire Gauge
◆ 135° Split Point
◆ Ground Flute
◆ Straight Shank
◆ Heavy Duty Web
◆ Black Oxide Finish
◆ M2 HSS

- ➔ Cast Iron
➔ Steel
➔ Steel Forging
➔ Light Gauge Stainless Steel

Table with 14 columns: Part #, Size, Dec., OAL, Flute, Qty., List, Part #, Size, Dec., OAL, Flute, Qty., List. Contains 30 rows of drill specifications.



NOTE:
SIZES 40 → 60
HAVE NO
SPLIT POINT.



**Jobber Drills - HEAVY DUTY 3/8" Shank - BLACK OXIDE FINISH M2 HSS**

Part #	Size	Dec.	OAL	Flute	Qty.	List	Part #	Size	Dec.	OAL	Flute	Qty.	List
206R82564	25/64"	.3906	5-1/8"	3-3/4"	6	\$14.41	206R82964	29/64"	.4531	5-5/8"	4-3/16"	6	\$18.68
206R82664	13/32"	.4062	5-1/4"	3-1/8"	6	\$14.63	206R83064	15/32"	.4688	5-3/4"	4-5/16"	6	\$19.06
206R82764	27/64"	.4219	5-3/8"	3-15/16"	6	\$15.79	206R83164	31/64"	.4844	5-7/8"	4-3/8"	6	\$19.67
206R82864	7/16"	.4375	5-1/2"	4-1/16"	6	\$16.74	206R83264	1/2"	.5000	6"	4-1/2"	6	\$20.23

◆ Same as 206SP with 3/8" Shank.



**Letter Drills - HEAVY DUTY - BLACK OXIDE FINISH M2 HSS**

Part #	Size	Dec.	OAL	Flute	Qty.	List	Part #	Size	Dec.	OAL	Flute	Qty.	List
208SP000A	A	.2340	3-7/8"	2-5/8"	12	\$3.03	208SP000N	N	.3020	4-3/8"	3-1/16"	6	\$5.21
208SP000B	B	.2380	4"	2-3/4"	12	\$3.17	208SP000O	O	.3160	4-1/2"	3-3/16"	6	\$5.34
208SP000C	C	.2420	4"	2-3/4"	12	\$3.17	208SP000P	P	.3230	4-5/8"	3-5/16"	6	\$5.77
208SP000D	D	.2460	4"	2-3/4"	12	\$3.17	208SP000Q	Q	.3320	4-3/4"	3-7/16"	6	\$5.86
208SP000E	E	.2500	4"	2-3/4"	12	\$3.17	208SP000R	R	.3390	4-3/4"	3-7/16"	6	\$5.86
208SP000F	F	.2570	4-1/8"	2-7/8"	12	\$3.89	208SP000S	S	.3480	4-7/8"	3-1/2"	6	\$7.18
208SP000G	G	.2610	4-1/8"	2-7/8"	12	\$3.89	208SP000T	T	.3580	4-7/8"	3-1/2"	6	\$7.18
208SP000H	H	.2660	4-1/8"	2-7/8"	12	\$3.97	208SP000U	U	.3680	5"	3-5/8"	6	\$7.37
208SP000I	I	.2720	4-1/8"	2-7/8"	12	\$3.97	208SP000V	V	.3770	5"	3-5/8"	6	\$7.37
208SP000J	J	.2770	4-1/8"	2-7/8"	12	\$4.42	208SP000W	W	.3860	5-1/8"	3-3/4"	6	\$8.37
208SP000K	K	.2810	4-1/4"	2-15/16"	12	\$4.42	208SP000X	X	.3970	5-1/8"	3-3/4"	6	\$9.56
208SP000L	L	.2900	4-1/4"	2-15/16"	6	\$5.09	208SP000Y	Y	.4040	5-1/4"	3-7/8"	6	\$9.86
208SP000M	M	.2950	4-3/8"	3-1/16"	6	\$5.21	208SP000Z	Z	.4130	5-1/4"	3-7/8"	6	\$11.08

- ◆ Jobber Length
- ◆ 135° Split Point
- ◆ Ground Flute
- ◆ Straight Shank
- ◆ Heavy Duty Web
- ◆ Black Oxide Finish
- ◆ M2 HSS

- Cast Iron
- Steel
- Steel Forging
- Light Gauge Stainless Steel



**Metric Drills - General Purpose - BLACK OXIDE FINISH M2 HSS**

Part #	Size	Dec.	OAL	Flute	Qty.	List	Part #	Size	Dec.	OAL	Flute	Qty.	List
205HS0010	1	.0393	41	18	12	\$1.91	205HS0075	7.5	.2953	111	78	12	\$6.08
205HS0015	1.5	.0591	48	22	12	\$1.91	205HS0080	8	.3150	114	81	12	\$7.02
205HS0020	2	.0787	54	29	12	\$1.91	205HS0085	8.5	.3346	121	87	6	\$8.37
205HS0025	2.5	.0984	60	35	12	\$1.91	205HS0090	9	.3543	124	89	6	\$9.37
205HS0030	3	.1181	70	41	12	\$1.91	205HS0095	9.5	.3740	127	92	6	\$9.70
205HS0035	3.5	.1378	73	45	12	\$2.06	205HS0100	10	.3937	130	95	6	\$11.42
205HS0040	4	.1575	83	54	12	\$2.48	205HS0105	10.5	.4134	137	100	6	\$12.49
205HS0045	4.5	.1772	86	56	12	\$2.88	205HS0110	11	.4331	140	103	6	\$12.66
205HS0050	5	.1969	92	62	12	\$3.14	205HS0115	11.5	.4528	143	106	6	\$14.73
205HS0055	5.5	.2165	95	64	12	\$3.62	205HS0120	12	.4724	150	111	6	\$16.42
205HS0060	6	.2362	102	70	12	\$4.30	205HS0125	12.5	.4921	152	114	6	\$16.42
205HS0065	6.5	.2559	105	73	12	\$4.63	205HS0130	13	.5118	168	122	6	\$19.46
205HS0070	7	.2756	105	73	12	\$5.15							

- ◆ Metric Size
- ◆ 118° Point
- ◆ General Purpose
- ◆ Roll Forged
- ◆ Straight Shank
- ◆ Black Oxide Finish
- ◆ M2 HSS

- Cast Iron
- Steel
- Steel Forging
- Light to Medium Materials



- ◆ Stub Length
  - ◆ 135° Split Point
  - ◆ Ground Flute
  - ◆ Straight Shank
  - ◆ Heavy Duty Web
  - ◆ Black Oxide Finish
  - ◆ M2 HSS
- ➔ Cast Iron
  - ➔ Steel
  - ➔ Steel Forging
  - ➔ Stainless Steel
  - ➔ Sheet Metal
  - ➔ Automotive



**STUB Fractional - HEAVY DUTY**

Part #	Size	Dec.	OAL	Flute	Qty.	List
209SM0464	1/16"	.0625	1-5/8"	5/8"	12	\$1.10
209SM0564	5/64"	.0781	1-11/16"	11/16"	12	\$1.10
209SM0664	3/32"	.0938	1-3/4"	3/4"	12	\$1.10
209SM0764	7/64"	.1094	1-13/16"	13/16"	12	\$1.10
209SM0864	1/8"	.1250	1-7/8"	7/8"	12	\$1.10
209SM0964	9/64"	.1406	1-15/16"	15/16"	12	\$1.25
209SM1064	5/32"	.1562	2-1/16"	1"	12	\$1.43
209SM1164	11/64"	.1719	2-1/8"	1-1/16"	12	\$1.74
209SM1264	3/16"	.1875	2-3/16"	1-1/8"	12	\$2.01
209SM1364	13/64"	.2031	2-1/4"	1-3/16"	12	\$2.27
209SM1464	7/32"	.2188	2-3/8"	1-1/4"	12	\$2.48
209SM1564	15/64"	.2344	2-7/16"	1-5/16"	12	\$2.90
209SM1664	1/4"	.2500	2-1/2"	1-3/8"	12	\$3.43
209SM1764	17/64"	.2656	2-5/8"	1-7/16"	12	\$3.96
209SM1864	9/32"	.2812	2-11/16"	1-1/2"	12	\$4.22
209SM1964	19/64"	.2969	2-3/4"	1-9/16"	12	\$4.80
209SM2064	5/16"	.3125	2-13/16"	1-5/8"	12	\$5.38
209SM2164	21/64"	.3281	2-15/16"	1-11/16"	6	\$6.28
209SM2264	11/32"	.3438	3"	1-11/16"	6	\$6.76
209SM2364	23/64"	.3594	3-1/16"	1-3/4"	6	\$7.23
209SM2464	3/8"	.3750	3-1/8"	1-13/16"	6	\$8.13
209SM2564	25/64"	.3906	3-1/4"	1-7/8"	6	\$9.61
209SM2664	13/32"	.4062	3-5/16"	1-15/16"	6	\$10.29
209SM2764	27/64"	.4219	3-3/8"	2"	6	\$10.93
209SM2864	7/16"	.4375	3-7/16"	2-1/16"	6	\$11.45
209SM2964	29/64"	.4531	3-9/16"	2-1/8"	6	\$12.72
209SM3064	15/32"	.4688	3-5/8"	2-1/8"	6	\$13.93
209SM3164	31/64"	.4844	3-11/16"	2-3/16"	6	\$15.31
209SM3264	1/2"	.5000	3-3/4"	2-1/4"	6	\$16.04



**STUB Wire Gauge - HEAVY DUTY**

Part #	Size	Dec.	OAL	Flute	Qty.	List
210SM0001	1	.2280	2-7/16"	1-15/16"	12	\$2.85
210SM0002	2	.2210	2-7/16"	1-15/16"	12	\$2.85
210SM0003	3	.2130	2-3/8"	1-1/4"	12	\$2.42
210SM0004	4	.2090	2-3/8"	1-1/4"	12	\$2.42
210SM0005	5	.2055	2-3/8"	1-1/4"	12	\$2.42
210SM0006	6	.2040	2-3/8"	1-1/4"	12	\$2.42
210SM0007	7	.2010	2-1/4"	1-3/16"	12	\$2.15
210SM0008	8	.1990	2-1/4"	1-3/16"	12	\$2.15
210SM0009	9	.1960	2-1/4"	1-3/16"	12	\$2.15
210SM0010	10	.1935	2-1/4"	1-3/16"	12	\$2.15
210SM0011	11	.1910	2-1/4"	1-3/16"	12	\$2.15
210SM0012	12	.1890	2-1/4"	1-3/16"	12	\$2.15
210SM0013	13	.1850	2-3/16"	1-1/8"	12	\$1.83
210SM0014	14	.1820	2-3/16"	1-1/8"	12	\$1.83
210SM0015	15	.1800	2-3/16"	1-1/8"	12	\$1.83
210SM0016	16	.1770	2-3/16"	1-1/8"	12	\$1.83
210SM0017	17	.1730	2-3/16"	1-1/8"	12	\$1.83
210SM0018	18	.1695	2-1/8"	1-1/16"	12	\$1.62
210SM0019	19	.1660	2-1/8"	1-1/16"	12	\$1.62
210SM0020	20	.1610	2-1/8"	1-1/16"	12	\$1.62
210SM0021	21	.1590	2-1/8"	1-1/16"	12	\$1.62
210SM0022	22	.1570	2-1/8"	1-1/16"	12	\$1.62
210SM0023	23	.1540	2-1/16"	1"	12	\$1.35
210SM0024	24	.1520	2-1/16"	1"	12	\$1.35
210SM0025	25	.1495	2-1/16"	1"	12	\$1.35
210SM0026	26	.1470	2-1/16"	1"	12	\$1.35
210SM0027	27	.1440	2-1/16"	1"	12	\$1.35
210SM0028	28	.1405	1-15/16"	15/16"	12	\$1.17
210SM0029	29	.1360	1-15/16"	15/16"	12	\$1.17
210SM0030	30	.1285	1-15/16"	15/16"	12	\$1.17
210SM0031	31	.1200	1-7/8"	7/8"	12	\$1.17
210SM0032	32	.1160	1-7/8"	7/8"	12	\$1.17
210SM0033	33	.1130	1-7/8"	7/8"	12	\$1.17
210SM0034	34	.1110	1-7/8"	7/8"	12	\$1.17
210SM0035	35	.1100	1-7/8"	7/8"	12	\$1.17
210SM0036	36	.1065	1-13/16"	13/16"	12	\$1.17
210SM0037	37	.1040	1-13/16"	13/16"	12	\$1.17
210SM0038	38	.1015	1-13/16"	13/16"	12	\$1.17
210SM0039	39	.0995	1-13/16"	13/16"	12	\$1.17
210SM0040	40	.0980	1-13/16"	13/16"	12	\$1.17



**Silver & Deming - 1/2" Shank - M2 HSS**

Part #	Size	Dec.	OAL	Flute	Qty.	List	Part #	Size	Dec.	OAL	Flute	Qty.	List
201SD3364	33/64"	.5156	6"	2-3/4"	1	\$14.44	201SD5364	53/64"	.8281	6"	2-3/4"	1	\$26.78
201SD3464	17/32"	.5312	6"	2-3/4"	1	\$14.67	201SD5464	27/32"	.8438	6"	2-3/4"	1	\$27.03
201SD3564	35/64"	.5469	6"	2-3/4"	1	\$14.89	201SD5564	55/64"	.8594	6"	2-3/4"	1	\$27.65
201SD3664	9/16"	.5625	6"	2-3/4"	1	\$14.89	201SD5664	7/8"	.8750	6"	2-3/4"	1	\$27.65
201SD3764	37/64"	.5781	6"	2-3/4"	1	\$16.67	201SD5764	57/64"	.8906	6"	2-3/4"	1	\$30.49
201SD3864	19/32"	.5938	6"	2-3/4"	1	\$16.67	201SD5864	29/32"	.9062	6"	2-3/4"	1	\$30.49
201SD3964	39/64"	.6094	6"	2-3/4"	1	\$16.90	201SD5964	59/64"	.9219	6"	2-3/4"	1	\$30.80
201SD4064	5/8"	.6250	6"	2-3/4"	1	\$16.90	201SD6064	15/16"	.9375	6"	2-3/4"	1	\$30.80
201SD4164	41/64"	.6406	6"	2-3/4"	1	\$18.05	201SD6164	61/64"	.9531	6"	2-3/4"	1	\$33.15
201SD4264	21/32"	.6562	6"	2-3/4"	1	\$18.05	201SD6264	31/32"	.9688	6"	2-3/4"	1	\$33.15
201SD4364	43/64"	.6719	6"	2-3/4"	1	\$18.84	201SD6364	63/64"	.9844	6"	2-3/4"	1	\$35.35
201SD4464	11/16"	.6875	6"	2-3/4"	1	\$21.67	201SD6464	1"	1.0000	6"	2-3/4"	1	\$38.89
201SD4564	45/64"	.7031	6"	2-3/4"	1	\$22.81	201SD6864	1-1/16"	1.0625	6"	2-3/4"	1	\$57.78
201SD4664	23/32"	.7188	6"	2-3/4"	1	\$22.81	201SD7264	1-1/8"	1.1250	6"	2-3/4"	1	\$60.60
201SD4764	47/64"	.7344	6"	2-3/4"	1	\$23.50	201SD7664	1-3/16"	1.1875	6"	2-3/4"	1	\$72.28
201SD4864	3/4"	.7500	6"	2-3/4"	1	\$23.50	201SD8064	1-1/4"	1.2500	6"	2-3/4"	1	\$83.70
201SD4964	49/64"	.7656	6"	2-3/4"	1	\$25.21	201SD8464	1-5/16"	1.3125	6"	2-3/4"	1	\$87.90
201SD5064	25/32"	.7812	6"	2-3/4"	1	\$25.21	201SD8864	1-3/8"	1.3750	6"	2-3/4"	1	\$95.50
201SD5164	51/64"	.7969	6"	2-3/4"	1	\$25.64	201SD9664	1-1/2"	1.5000	6"	2-3/4"	1	\$106.55
201SD5264	13/16"	.8125	6"	2-3/4"	1	\$25.64							

- ◆ 6" Length
- ◆ 118° Point
- ◆ Ground Flute
- ◆ 1/2" Shank
- ◆ Black Oxide Finish
- ◆ M2 HSS

- Cast Iron
- Steel
- Steel Forging
- Light to Medium Materials



**Silver & Deming - 3/8" Shank - M2 HSS**

Part #	Size	Dec.	OAL	Flute	Qty.	List	Part #	Size	Dec.	OAL	Flute	Qty.	List
201R83364	33/64"	.5156	6"	2-3/4"	1	\$26.13	201R84164	41/64"	.6406	6"	2-3/4"	1	\$32.06
201R83464	17/32"	.5312	6"	2-3/4"	1	\$26.76	201R84264	21/32"	.6562	6"	2-3/4"	1	\$32.06
201R83564	35/64"	.5469	6"	2-3/4"	1	\$27.72	201R84364	43/64"	.6719	6"	2-3/4"	1	\$32.90
201R83664	9/16"	.5625	6"	2-3/4"	1	\$27.72	201R84464	11/16"	.6875	6"	2-3/4"	1	\$33.57
201R83764	37/64"	.5781	6"	2-3/4"	1	\$29.91	201R84564	45/64"	.7031	6"	2-3/4"	1	\$35.79
201R83864	19/32"	.5938	6"	2-3/4"	1	\$29.91	201R84664	23/32"	.7188	6"	2-3/4"	1	\$38.00
201R83964	39/64"	.6094	6"	2-3/4"	1	\$29.91	201R84764	47/64"	.7344	6"	2-3/4"	1	\$40.51
201R84064	5/8"	.6250	6"	2-3/4"	1	\$30.78	201R84864	3/4"	.7500	6"	2-3/4"	1	\$43.91

- ◆ 6" Length
- ◆ 118° Point
- ◆ Ground Flute
- ◆ 1/2" Shank
- ◆ Black Oxide Finish
- ◆ M2 HSS

- Cast Iron
- Steel
- Steel Forging
- Light to Medium Materials





INTERNATIONAL TOOL MANUFACTURING

(718) 446-0711 • (800) 247-5696

Fax (718) 899-6553

# 100% LAB TESTED

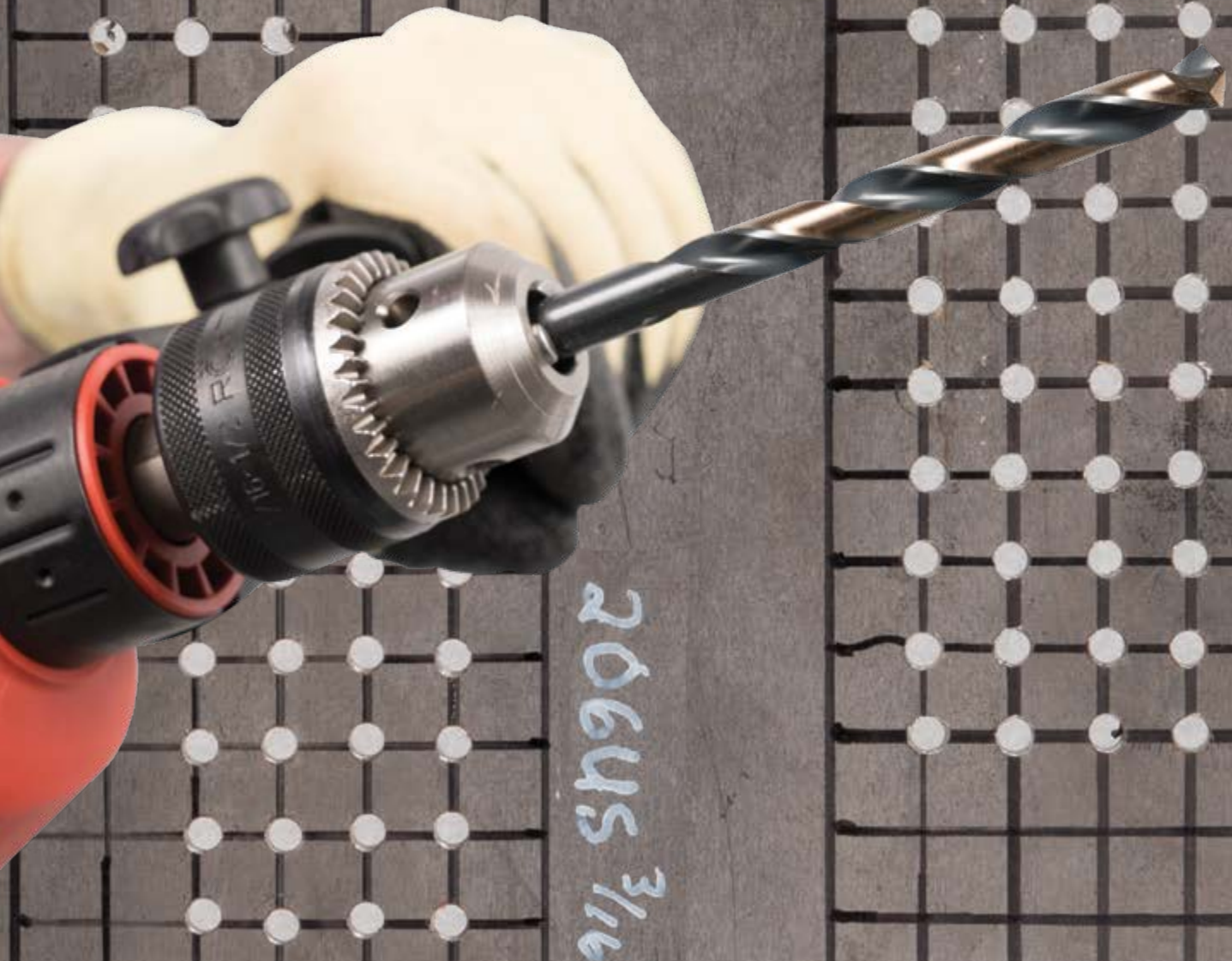

## **Black & Gold**

The Most Recognizable Finish Anywhere.



### Black & Gold Jobber Drills - HEAVY DUTY - M2 HSS

Part #	Size	Dec.	OAL	Flute	Qty.	List	Part #	Size	Dec.	OAL	Flute	Qty.	List
206US0464	1/16"	.0625	1-7/8"	7/8"	12	\$1.39	206US1964	19/64"	.2969	4-3/8"	3-1/16"	12	\$4.96
206US0564	5/64"	.0781	2"	1"	12	\$1.39	206US2064	5/16"	.3125	4-1/2"	3-3/16"	12	\$5.14
206US0664	3/32"	.0938	2-1/4"	1-1/4"	12	\$1.39	206US2164	21/64"	.3281	4-5/8"	3-5/16"	6	\$5.67
206US0764	7/64"	.1094	2-5/8"	1-1/2"	12	\$1.39	206US2264	11/32"	.3438	4-3/4"	3-7/16"	6	\$6.35
206US0864	1/8"	.1250	2-3/4"	1-5/8"	12	\$1.55	206US2364	23/64"	.3594	4-7/8"	3-1/2"	6	\$7.22
206US0964	9/64"	.1406	2-7/8"	1-3/4"	12	\$1.66	206US2464	3/8"	.3750	5"	3-5/8"	6	\$7.42
206US1064	5/32"	.1562	3-1/8"	2"	12	\$1.74	206US2564	25/64"	.3906	5-1/8"	3-3/4"	6	\$8.50
206US1164	11/64"	.1719	3-1/4"	2-1/8"	12	\$1.97	206US2664	13/32"	.4062	5-1/4"	3-7/8"	6	\$9.63
206US1264	3/16"	.1875	3-1/2"	2-5/16"	12	\$2.14	206US2764	27/64"	.4219	5-3/8"	3-15/16"	6	\$10.82
206US1364	13/64"	.2031	3-5/8"	2-7/16"	12	\$2.53	206US2864	7/16"	.4375	5-1/2"	4-1/16"	6	\$12.14
206US1464	7/32"	.2188	3-3/4"	2-1/2"	12	\$2.58	206US2964	29/64"	.4531	5-5/8"	4-3/16"	6	\$12.77
206US1564	15/64"	.2344	3-7/8"	2-5/8"	12	\$2.94	206US3064	15/32"	.4688	5-3/4"	4-5/16"	6	\$13.19
206US1664	1/4"	.2500	4"	2-3/4"	12	\$3.37	206US3164	31/64"	.4844	5-7/8"	4-3/8"	6	\$15.38
206US1764	17/64"	.2656	4-1/8"	2-7/8"	12	\$3.71	206US3264	1/2"	.5000	6"	4-1/2"	6	\$16.04
206US1864	9/32"	.2812	4-1/4"	2-15/16"	12	\$4.59							

- ◆ Jobber Length
- ◆ 135° Split Point
- ◆ Ground Flute
- ◆ Straight Shank
- ◆ Heavy Duty Web
- ◆ Black & Gold Finish
- ◆ M2 HSS

- Cast Iron
- Steel
- Steel Forging
- Stainless Steel

### Black & Gold Wire Gauge Drills - HEAVY DUTY - M2 HSS

Part #	Size	Dec.	OAL	Flute	Qty.	List	Part #	Size	Dec.	OAL	Flute	Qty.	List
207US-01	1	.2280	3-7/8"	2-5/8"	12	\$2.80	207US-31	31	.1200	2-3/4"	1-5/8"	12	\$1.60
207US-02	2	.2210	3-7/8"	2-5/8"	12	\$2.80	207US-32	32	.1160	2-3/4"	1-5/8"	12	\$1.55
207US-03	3	.2130	3-3/4"	2-1/2"	12	\$2.80	207US-33	33	.1130	2-5/8"	1-1/2"	12	\$1.55
207US-04	4	.2090	3-3/4"	2-1/2"	12	\$2.80	207US-34	34	.1110	2-5/8"	1-1/2"	12	\$1.55
207US-05	5	.2055	3-3/4"	2-1/2"	12	\$2.80	207US-35	35	.1100	2-5/8"	1-1/2"	12	\$1.55
207US-06	6	.2040	3-3/4"	2-1/2"	12	\$2.80	207US-36	36	.1065	2-1/2"	1-7/16"	12	\$1.55
207US-07	7	.2010	3-5/8"	2-7/16"	12	\$2.46	207US-37	37	.1040	2-1/2"	1-7/16"	12	\$1.55
207US-08	8	.1990	3-5/8"	2-7/16"	12	\$2.46	207US-38	38	.1015	2-1/2"	1-7/16"	12	\$1.55
207US-09	9	.1960	3-5/8"	2-7/16"	12	\$2.46	207US-39	39	.0995	2-3/8"	1-3/8"	12	\$1.55
207US-10	10	.1935	3-5/8"	2-7/16"	12	\$2.46	207US-40	40	.0980	2-3/8"	1-3/8"	12	\$1.55
207US-11	11	.1910	3-1/2"	2-5/16"	12	\$2.25	207US-41	41	.0960	2-3/8"	1-3/8"	12	\$1.45
207US-12	12	.1890	3-1/2"	2-5/16"	12	\$2.25	207US-42	42	.0935	2-1/4"	1-1/4"	12	\$1.45
207US-13	13	.1850	3-1/2"	2-5/16"	12	\$2.25	207US-43	43	.0890	2-1/4"	1-1/4"	12	\$1.45
207US-14	14	.1820	3-3/8"	2-3/16"	12	\$2.25	207US-44	44	.0860	2-1/8"	1-1/8"	12	\$1.45
207US-15	15	.1800	3-3/8"	2-3/16"	12	\$2.25	207US-45	45	.0820	2-1/8"	1-1/8"	12	\$1.45
207US-16	16	.1770	3-3/8"	2-3/16"	12	\$2.25	207US-46	46	.0810	2-1/8"	1-1/8"	12	\$1.45
207US-17	17	.1730	3-3/8"	2-3/16"	12	\$2.25	207US-47	47	.0785	2"	1"	12	\$1.45
207US-18	18	.1695	3-1/4"	2-1/8"	12	\$1.98	207US-48	48	.0760	2"	1"	12	\$1.45
207US-19	19	.1660	3-1/4"	2-1/8"	12	\$1.98	207US-49	49	.0730	2"	1"	12	\$1.45
207US-20	20	.1610	3-1/4"	2-1/8"	12	\$1.98	207US-50	50	.0700	2"	1"	12	\$1.45
207US-21	21	.1590	3-1/4"	2-1/8"	12	\$1.98	207US-51	51	.0670	2"	1"	12	\$1.45
207US-22	22	.1570	3-1/8"	2"	12	\$1.98	207US-52	52	.0635	1-7/8"	7/8"	12	\$1.45
207US-23	23	.1540	3-1/8"	2"	12	\$1.68	207US-53	53	.0595	1-7/8"	7/8"	12	\$1.45
207US-24	24	.1520	3-1/8"	2"	12	\$1.68	207US-54	54	.0550	1-7/8"	7/8"	12	\$1.45
207US-25	25	.1495	3"	1-7/8"	12	\$1.68	207US-55	55	.0520	1-7/8"	7/8"	12	\$1.45
207US-26	26	.1470	3"	1-7/8"	12	\$1.68	207US-56	56	.0465	1-3/4"	3/4"	12	\$1.45
207US-27	27	.1440	3"	1-7/8"	12	\$1.68	207US-57	57	.0430	1-3/4"	3/4"	12	\$1.45
207US-28	28	.1405	2-7/8"	1-3/4"	12	\$1.68	207US-58	58	.0420	1-5/8"	11/16"	12	\$1.45
207US-29	29	.1360	2-7/8"	1-3/4"	12	\$1.68	207US-59	59	.0410	1-5/8"	11/16"	12	\$1.45
207US-30	30	.1285	2-3/4"	1-5/8"	12	\$1.68	207US-60	60	.0400	1-5/8"	11/16"	12	\$1.45



**NOTE:**  
SIZES 40 → 60  
HAVE NO  
SPLIT POINT.



**Black & Gold Jobber Drills - HEAVY DUTY 3/8" Shank - M2 HSS**

- ◆ Jobber Length
- ◆ 135° Split Point
- ◆ Ground Flute
- ◆ Straight Shank
- ◆ Heavy Duty Web
- ◆ Black & Gold Finish
- ◆ M2 HSS

Part #	Size	Dec.	OAL	Flute	Qty.	List	Part #	Size	Dec.	OAL	Flute	Qty.	List
206U82564	25/64"	.3906	5-1/8"	3-3/4"	6	\$16.29	206U82964	29/64"	.4531	5-5/8"	4-3/16"	6	\$21.12
206U82664	13/32"	.4062	5-1/4"	3-1/8"	6	\$16.54	206U83064	15/32"	.4688	5-3/4"	4-5/16"	6	\$21.55
206U82764	27/64"	.4219	5-3/8"	3-15/16"	6	\$17.86	206U83164	31/64"	.4844	5-7/8"	4-3/8"	6	\$22.24
206U82864	7/16"	.4375	5-1/2"	4-1/16"	6	\$18.92	206U83264	1/2"	.5000	6"	4-1/2"	6	\$22.87

- Cast Iron
- Steel
- Steel Forging
- Stainless Steel



**Black & Gold Mechanics Length Drills - HEAVY DUTY - M2 HSS**

- ◆ Mechanics Length
- ◆ 135° Split Point
- ◆ 3-Flat Shank (3/16" → 1/2")
- ◆ Black & Gold Finish
- ◆ Heavy Duty Web for Strength & Rigidity
- ◆ M2 HSS

Part #	Size	Dec.	OAL	Flute	Qty.	List	Part #	Size	Dec.	OAL	Flute	Qty.	List
208MC0464	1/16"	.0625	1 7/8"	7/8"	12	\$1.60	208MC1964	19/64"	.2969	3-7/8"	2-3/8"	12	\$6.08
208MC0564	5/64"	.0781	2"	1"	12	\$1.60	208MC2064	5/16"	.3125	4"	2-1/2"	12	\$6.17
208MC0664	3/32"	.0938	2-1/4"	1-1/4"	12	\$1.75	208MC2164	21/64"	.3281	4-1/16"	2-9/16"	6	\$6.95
208MC0764	7/64"	.1094	2-3/8"	1-5/16"	12	\$1.75	208MC2264	11/32"	.3438	4-1/8"	2-5/8"	6	\$7.58
208MC0864	1/8"	.1250	2-1/2"	1-7/16"	12	\$1.85	208MC2364	23/64"	.3594	4-3/16"	2-11/16"	6	\$8.02
208MC0964	9/64"	.1406	2-5/8"	1-9/16"	12	\$1.94	208MC2464	3/8"	.3750	4-1/4"	2-11/16"	6	\$8.31
208MC1064	5/32"	.1562	2-3/4"	1-11/16"	12	\$2.43	208MC2564	25/64"	.3906	4-5/16"	2-3/4"	6	\$9.55
208MC1164	11/64"	.1719	2-7/8"	1-13/16"	12	\$2.53	208MC2664	13/32"	.4062	4-3/8"	2-13/16"	6	\$9.90
208MC1264	3/16"	.1875	3"	1-7/8"	12	\$3.21	208MC2764	27/64"	.4219	4-7/16"	2-7/8"	6	\$10.54
208MC1364	13/64"	.2031	3-1/8"	1-15/16"	12	\$3.40	208MC2864	7/16"	.4375	4-1/2"	2-15/16"	6	\$11.48
208MC1464	7/32"	.2188	3-1/4"	2"	12	\$3.60	208MC2964	29/64"	.4531	4-5/8"	3"	6	\$13.12
208MC1564	15/64"	.2344	3-3/8"	2"	12	\$3.84	208MC3064	15/32"	.4688	4-3/4"	3-1/8"	6	\$13.86
208MC1664	1/4"	.2500	3-1/2"	2"	12	\$4.03	208MC3164	31/64"	.4844	4-7/8"	3-1/4"	6	\$13.91
208MC1764	17/64"	.2656	3-5/8"	2-1/8"	12	\$4.33	208MC3264	1/2"	.5000	5"	3-3/8"	6	\$14.85
208MC1864	9/32"	.2812	3-3/4"	2-1/4"	12	\$5.25							

- Cast Iron
- Steel
- Steel Forging
- Stainless Steel



**Black & Gold**

- ◆ Jobber Length
- ◆ 135° Split Point
- ◆ Ground Flute
- ◆ Straight Shank
- ◆ Heavy Duty Web
- ◆ Black & Gold Finish
- ◆ M2 HSS

- Cast Iron
- Steel
- Steel Forging
- Stainless Steel

**Black & Gold Letter Drills - HEAVY DUTY - M2 HSS**

Part #	Size	Dec.	OAL	Flute	Qty.	List	Part #	Size	Dec.	OAL	Flute	Qty.	List
208US-A	A	.234	3-7/8"	2-5/8"	12	\$4.38	208US-N	N	.302	4-3/8"	3-1/16"	6	\$5.74
208US-B	B	.238	4"	2-3/4"	12	\$4.38	208US-O	O	.316	4-1/2"	3-3/16"	6	\$6.20
208US-C	C	.242	4"	2-3/4"	12	\$4.38	208US-P	P	.323	4-5/8"	3-5/16"	6	\$6.78
208US-D	D	.246	4"	2-3/4"	12	\$4.38	208US-Q	Q	.332	4-3/4"	3-7/16"	6	\$7.08
208US-E	E	.250	4"	2-3/4"	12	\$4.38	208US-R	R	.339	4-3/4"	3-7/16"	6	\$7.08
208US-F	F	.257	4-1/8"	2-7/8"	12	\$4.58	208US-S	S	.348	4-7/8"	3-1/2"	6	\$7.76
208US-G	G	.261	4-1/8"	2-7/8"	12	\$4.58	208US-T	T	.358	4-7/8"	3-1/2"	6	\$8.46
208US-H	H	.266	4-1/8"	2-7/8"	12	\$4.58	208US-U	U	.368	5"	3-5/8"	6	\$9.15
208US-I	I	.272	4-1/8"	2-7/8"	12	\$5.01	208US-V	V	.377	5"	3-5/8"	6	\$9.15
208US-J	J	.277	4-1/8"	2-7/8"	12	\$5.01	208US-W	W	.386	5-1/8"	3-3/4"	6	\$9.15
208US-K	K	.281	4-1/4"	2-15/16"	12	\$5.01	208US-X	X	.397	5-1/8"	3-3/4"	6	\$10.96
208US-L	L	.290	4-1/4"	2-15/16"	6	\$5.59	208US-Y	Y	.404	5-1/4"	3-7/8"	6	\$11.19
208US-M	M	.295	4-3/8"	3-1/16"	6	\$5.74	208US-Z	Z	.413	5-1/4"	3-7/8"	6	\$12.06



**Black & Gold**

- ◆ 6" Length
- ◆ 118° Split Point
- ◆ Ground Flute
- ◆ 3-Flat Round 1/2" Shank
- ◆ Heavy Duty Web
- ◆ Black & Gold Finish
- ◆ M2 HSS

- Cast Iron
- Steel
- Steel Forging
- Stainless Steel

**Black & Gold Silver & Deming - 1/2" Shank - M2 HSS**

Part #	Size	Dec.	OAL	Flute	Qty.	List	Part #	Size	Dec.	OAL	Flute	Qty.	List
201US3364	33/64"	.5156	6"	2-3/4"	1	\$17.24	201US5164	51/64"	.7969	6"	2-3/4"	1	\$32.04
201US3464	17/32"	.5312	6"	2-3/4"	1	\$17.24	201US5264	13/16"	.8125	6"	2-3/4"	1	\$32.04
201US3564	35/64"	.5469	6"	2-3/4"	1	\$17.92	201US5364	53/64"	.8281	6"	2-3/4"	1	\$33.04
201US3664	9/16"	.5625	6"	2-3/4"	1	\$17.92	201US5464	27/32"	.8438	6"	2-3/4"	1	\$33.04
201US3764	37/64"	.5781	6"	2-3/4"	1	\$18.44	201US5564	55/64"	.8594	6"	2-3/4"	1	\$35.40
201US3864	19/32"	.5938	6"	2-3/4"	1	\$18.44	201US5664	7/8"	.8750	6"	2-3/4"	1	\$35.40
201US3964	39/64"	.6094	6"	2-3/4"	1	\$18.72	201US5764	57/64"	.8906	6"	2-3/4"	1	\$35.90
201US4064	5/8"	.6250	6"	2-3/4"	1	\$19.66	201US5864	29/32"	.9062	6"	2-3/4"	1	\$35.90
201US4164	41/64"	.6406	6"	2-3/4"	1	\$20.62	201US5964	59/64"	.9219	6"	2-3/4"	1	\$37.60
201US4264	21/32"	.6562	6"	2-3/4"	1	\$20.62	201US6064	15/16"	.9375	6"	2-3/4"	1	\$37.60
201US4364	43/64"	.6719	6"	2-3/4"	1	\$22.35	201US6164	61/64"	.9531	6"	2-3/4"	1	\$39.88
201US4464	11/16"	.6875	6"	2-3/4"	1	\$22.35	201US6264	31/32"	.9688	6"	2-3/4"	1	\$39.88
201US4564	45/64"	.7031	6"	2-3/4"	1	\$23.50	201US6364	63/64"	.9844	6"	2-3/4"	1	\$42.04
201US4664	23/32"	.7188	6"	2-3/4"	1	\$23.50	201US6464	1"	1.0000	6"	2-3/4"	1	\$42.04
201US4764	47/64"	.7344	6"	2-3/4"	1	\$30.36	201US6864	1-1/16"	1.0625	6	2-3/4"	1	\$58.72
201US4864	3/4"	.7500	6"	2-3/4"	1	\$30.36	201US7264	1-1/8"	1.1250	6	2-3/4"	1	\$62.13
201US4964	49/64"	.7656	6"	2-3/4"	1	\$31.32	201US7664	1-3/16"	1.1875	6	2-3/4"	1	\$68.95
201US5064	25/32"	.7812	6"	2-3/4"	1	\$31.32	201US8064	1-1/4"	1.2500	6	2-3/4"	1	\$83.70



Cobalt Jobber Drills - HEAVY DUTY - M35 COBALT

- ◆ Jobber Length
- ◆ 135° Split Point
- ◆ Ground Flute
- ◆ Straight Shank
- ◆ Heavy Duty Web
- ◆ Gold Finish
- ◆ M35 Cobalt
- ➔ Hardened Steel
- ➔ Stainless Steel
- ➔ High Temp Alloys
- ➔ Heat Treated Materials
- ➔ Abrasive Plastics

Part #	Size	Dec.	OAL	Flute	Qty.	List	Part #	Size	Dec.	OAL	Flute	Qty.	List
219CO0464	1/16"	.0625	1-7/8"	7/8"	12	\$1.67	219CO1964	19/64"	.2969	4-3/8"	3-1/16"	12	\$7.63
219CO0564	5/64"	.0781	2"	1"	12	\$1.85	219CO2064	5/16"	.3125	4-1/2"	3-3/16"	12	\$8.18
219CO0664	3/32"	.0938	2-1/4"	1-1/4"	12	\$2.01	219CO2164	21/64"	.3281	4-5/8"	3-5/16"	6	\$8.98
219CO0764	7/64"	.1094	2-5/8"	1-1/2"	12	\$2.13	219CO2264	11/32"	.3438	4-3/4"	3-7/16"	6	\$10.39
219CO0864	1/8"	.1250	2-3/4"	1-5/8"	12	\$2.42	219CO2364	23/64"	.3594	4-7/8"	3-1/2"	6	\$11.81
219CO0964	9/64"	.1406	2-7/8"	1-3/4"	12	\$2.59	219CO2464	3/8"	.3750	5"	3-5/8"	6	\$12.39
219CO1064	5/32"	.1562	3-1/8"	2"	12	\$2.86	219CO2564	25/64"	.3906	5-1/8"	3-3/4"	6	\$13.45
219CO1164	11/64"	.1719	3-1/4"	2-1/8"	12	\$3.03	219CO2664	13/32"	.4062	5-1/4"	3-7/8"	6	\$14.37
219CO1264	3/16"	.1875	3-1/2"	2-5/16"	12	\$3.32	219CO2764	27/64"	.4219	5-3/8"	3-15/16"	6	\$15.19
219CO1364	13/64"	.2031	3-5/8"	2-7/16"	12	\$4.39	219CO2864	7/16"	.4375	5-1/2"	4-1/16"	6	\$15.80
219CO1464	7/32"	.2188	3-3/4"	2-1/2"	12	\$4.69	219CO2964	29/64"	.4531	5-5/8"	4-3/16"	6	\$18.93
219CO1564	15/64"	.2344	3-7/8"	2-5/8"	12	\$5.16	219CO3064	15/32"	.4688	5-3/4"	4-5/16"	6	\$19.29
219CO1664	1/4"	.2500	4"	2-3/4"	12	\$5.62	219CO3164	31/64"	.4844	5-7/8"	4-3/8"	6	\$19.75
219CO1764	17/64"	.2656	4-1/8"	2-7/8"	12	\$6.05	219CO3264	1/2"	.5000	6"	4-1/2"	6	\$20.34
219CO1864	9/32"	.2812	4-1/4"	2-15/16"	12	\$6.62							

Cobalt Wire Gauge Drills - HEAVY DUTY - M35 COBALT

Part #	Size	Dec.	OAL	Flute	Qty.	List	Part #	Size	Dec.	OAL	Flute	Qty.	List
220CO0001	1	.2280	3-7/8"	2-5/8"	12	\$5.21	220CO0031	31	.1200	2-3/4"	1-5/8"	12	\$2.52
220CO0002	2	.2210	3-7/8"	2-5/8"	12	\$5.21	220CO0032	32	.1160	2-3/4"	1-5/8"	12	\$2.52
220CO0003	3	.2130	3-3/4"	2-1/2"	12	\$5.21	220CO0033	33	.1130	2-5/8"	1-1/2"	12	\$2.52
220CO0004	4	.2090	3-3/4"	2-1/2"	12	\$5.21	220CO0034	34	.1110	2-5/8"	1-1/2"	12	\$2.52
220CO0005	5	.2055	3-3/4"	2-1/2"	12	\$5.21	220CO0035	35	.1100	2-5/8"	1-1/2"	12	\$2.52
220CO0006	6	.2040	3-3/4"	2-1/2"	12	\$5.21	220CO0036	36	.1065	2-1/2"	1-7/16"	12	\$2.52
220CO0007	7	.2010	3-5/8"	2-7/16"	12	\$3.95	220CO0037	37	.1040	2-1/2"	1-7/16"	12	\$2.52
220CO0008	8	.1990	3-5/8"	2-7/16"	12	\$3.95	220CO0038	38	.1015	2-1/2"	1-7/16"	12	\$2.52
220CO0009	9	.1960	3-5/8"	2-7/16"	12	\$3.95	220CO0039	39	.0995	2-3/8"	1-3/8"	12	\$2.52
220CO0010	10	.1935	3-5/8"	2-7/16"	12	\$3.95	220CO0040	40	.0980	2-3/8"	1-3/8"	12	\$2.52
220CO0011	11	.1910	3-1/2"	2-5/16"	12	\$3.95	220CO0041	41	.0960	2-3/8"	1-3/8"	12	\$2.52
220CO0012	12	.1890	3-1/2"	2-5/16"	12	\$3.95	220CO0042	42	.0935	2-1/4"	1-1/4"	12	\$2.52
220CO0013	13	.1850	3-1/2"	2-5/16"	12	\$3.95	220CO0043	43	.0890	2-1/4"	1-1/4"	12	\$2.52
220CO0014	14	.1820	3-3/8"	2-3/16"	12	\$3.95	220CO0044	44	.0860	2-1/8"	1-1/8"	12	\$2.52
220CO0015	15	.1800	3-3/8"	2-3/16"	12	\$3.95	220CO0045	45	.0820	2-1/8"	1-1/8"	12	\$2.52
220CO0016	16	.1770	3-3/8"	2-3/16"	12	\$3.95	220CO0046	46	.0810	2-1/8"	1-1/8"	12	\$2.52
220CO0017	17	.1730	3-3/8"	2-3/16"	12	\$3.95	220CO0047	47	.0785	2"	1"	12	\$2.52
220CO0018	18	.1695	3-1/4"	2-1/8"	12	\$3.95	220CO0048	48	.0760	2"	1"	12	\$2.52
220CO0019	19	.1660	3-1/4"	2-1/8"	12	\$2.93	220CO0049	49	.0730	2"	1"	12	\$2.52
220CO0020	20	.1610	3-1/4"	2-1/8"	12	\$2.93	220CO0050	50	.0700	2"	1"	12	\$2.52
220CO0021	21	.1590	3-1/4"	2-1/8"	12	\$2.93	220CO0051	51	.0670	2"	1"	12	\$2.52
220CO0022	22	.1570	3-1/8"	2"	12	\$2.93	220CO0052	52	.0635	1-7/8"	7/8"	12	\$2.52
220CO0023	23	.1540	3-1/8"	2"	12	\$2.93	220CO0053	53	.0595	1-7/8"	7/8"	12	\$2.52
220CO0024	24	.1520	3-1/8"	2"	12	\$2.93	220CO0054	54	.0550	1-7/8"	7/8"	12	\$2.52
220CO0025	25	.1495	3"	1-7/8"	12	\$2.93	220CO0055	55	.0520	1-7/8"	7/8"	12	\$2.52
220CO0026	26	.1470	3"	1-7/8"	12	\$2.93	220CO0056	56	.0465	1-3/4"	3/4"	12	\$2.52
220CO0027	27	.1440	3"	1-7/8"	12	\$2.93	220CO0057	57	.0430	1-3/4"	3/4"	12	\$2.52
220CO0028	28	.1405	2-7/8"	1-3/4"	12	\$2.93	220CO0058	58	.0420	1-5/8"	11/16"	12	\$2.52
220CO0029	29	.1360	2-7/8"	1-3/4"	12	\$2.93	220CO0059	59	.0410	1-5/8"	11/16"	12	\$2.52
220CO0030	30	.1285	2-3/4"	1-5/8"	12	\$2.52	220CO0060	60	.0400	1-5/8"	11/16"	12	\$2.52



NOTE: SIZES 40 → 60 HAVE NO SPLIT POINT.



**135°  
SPLIT  
POINT**

**Cobalt Jobber Drills - 3/8" Shank - M35 COBALT**

Part #	Size	Dec.	OAL	Flute	Qty.	List	Part #	Size	Dec.	OAL	Flute	Qty.	List
219R82564	25/64"	.3906	5-1/8"	3-3/4"	6	\$20.81	219R82964	29/64"	.4531	5-5/8"	4-3/16"	6	\$28.43
219R82664	13/32"	.4062	5-1/4"	3-1/8"	6	\$21.46	219R83064	15/32"	.4688	5-3/4"	4-5/16"	6	\$28.82
219R82764	27/64"	.4219	5-3/8"	3-15/16"	6	\$23.86	219R83164	31/64"	.4844	5-7/8"	4-3/8"	6	\$29.69
219R82864	7/16"	.4375	5-1/2"	4-1/16"	6	\$24.29	219R83264	1/2"	.5000	6"	4-1/2"	6	\$29.85

◆ Same as 219CO with 3/8" Shank.



**135°  
SPLIT  
POINT**

**Cobalt Stub Fractional - M35 COBALT**

Part #	Size	Dec.	OAL	Flute	Qty.	List	Part #	Size	Dec.	OAL	Flute	Qty.	List
CTS-0464	1/16"	.0625	1-5/8"	5/8"	12	\$1.25	CTS-1964	19/64"	.2969	2-3/4"	1-9/16"	12	\$6.94
CTS-0564	5/64"	.0781	1-11/16"	11/16"	12	\$1.25	CTS-2064	5/16"	.3125	2-13/16"	1-5/8"	12	\$8.33
CTS-0664	3/32"	.0938	1-3/4"	3/4"	12	\$1.33	CTS-2164	21/64"	.3281	2-15/16"	1-11/16"	6	\$8.96
CTS-0764	7/64"	.1094	1-13/16"	13/16"	12	\$1.50	CTS-2264	11/32"	.3438	3"	1-11/16"	6	\$9.58
CTS-0864	1/8"	.1250	1-7/8"	7/8"	12	\$1.75	CTS-2364	23/64"	.3594	3-1/16"	1-3/4"	6	\$11.18
CTS-0964	9/64"	.1406	1-15/16"	15/16"	12	\$2.00	CTS-2464	3/8"	.3750	3-1/8"	1-13/16"	6	\$10.76
CTS-1064	5/32"	.1562	2-1/16"	1"	12	\$2.15	CTS-2564	25/64"	.3906	3-1/4"	1-7/8"	6	\$12.71
CTS-1164	11/64"	.1719	2-1/8"	1-1/16"	12	\$2.22	CTS-2664	13/32"	.4062	3-5/16"	1-15/16"	6	\$14.41
CTS-1264	3/16"	.1875	2-3/16"	1-1/8"	12	\$2.50	CTS-2764	27/64"	.4219	3-3/8"	2"	6	\$15.11
CTS-1364	13/64"	.2031	2-1/4"	1-3/16"	12	\$2.92	CTS-2864	7/16"	.4375	3-7/16"	2-1/16"	6	\$16.37
CTS-1464	7/32"	.2188	2-3/8"	1-1/4"	12	\$3.40	CTS-2964	29/64"	.4531	3-9/16"	2-1/8"	6	\$16.19
CTS-1564	15/64"	.2344	2-7/16"	1-5/16"	12	\$3.96	CTS-3064	15/32"	.4688	3-5/8"	2-1/8"	6	\$17.80
CTS-1664	1/4"	.2500	2-1/2"	1-3/8"	12	\$4.86	CTS-3164	31/64"	.4844	3-11/16"	2-3/16"	6	\$18.56
CTS-1764	17/64"	.2656	2-5/8"	1-7/16"	12	\$5.21	CTS-3264	1/2"	.5000	3-3/4"	2-1/4"	6	\$18.59
CTS-1864	9/32"	.2812	2-11/16"	1-1/2"	12	\$5.76							

- ◆ Stub Length
- ◆ 135° Split Point
- ◆ Ground Flute
- ◆ Straight Shank
- ◆ Heavy Duty Web
- ◆ Gold Finish
- ◆ M35 Cobalt

- Cast Iron
- Hardened Steel
- Stainless Steel
- Sheet Metal
- High Temp Alloys
- Heat Treated Materials
- Automotive



**118°  
SPLIT  
POINT**

**Cobalt Silver & Deming - 1/2" Shank - M35 COBALT**

Part #	Size	Dec.	OAL	Flute	Qty.	List	Part #	Size	Dec.	OAL	Flute	Qty.	List
201CO3464	17/32"	.5312	6	2-3/4"	1	\$36.19	201CO5864	29/32"	.9062	6	2-3/4"	1	\$72.38
201CO3664	9/16"	.5625	6	2-3/4"	1	\$41.71	201CO6064	15/16"	.9375	6	2-3/4"	1	\$77.28
201CO3864	19/32"	.5938	6	2-3/4"	1	\$44.16	201CO6264	31/32"	.9688	6	2-3/4"	1	\$87.98
201CO4064	5/8"	.6250	6	2-3/4"	1	\$46.62	201CO6464	1"	1.0000	6	2-3/4"	1	\$90.78
201CO4264	21/32"	.6562	6	2-3/4"	1	\$49.69	201CO6864	1-1/16"	1.0625	6	2-3/4"	1	\$109.92
201CO4464	11/16"	.6875	6	2-3/4"	1	\$52.13	201CO7264	1-1/8"	1.1250	6	2-3/4"	1	\$125.10
201CO4664	23/32"	.7188	6	2-3/4"	1	\$54.59	201CO7664	1-3/16"	1.1875	6	2-3/4"	1	\$143.05
201CO4864	3/4"	.7500	6	2-3/4"	1	\$57.05	201CO8064	1-1/4"	1.2500	6	2-3/4"	1	\$166.16
201CO5064	25/32"	.7812	6	2-3/4"	1	\$59.49	201CO8464	1-5/16"	1.3125	6	2-3/4"	1	\$174.07
201CO5264	13/16"	.8125	6	2-3/4"	1	\$63.79	201CO8864	1-3/8"	1.3750	6	2-3/4"	1	\$179.45
201CO5464	27/32"	.8438	6	2-3/4"	1	\$66.24	201CO9664	1-1/2"	1.5000	6	2-3/4"	1	\$201.07
201CO5664	7/8"	.8750	6	2-3/4"	1	\$68.70							

- ◆ 6" Length
- ◆ 118° Split Point
- ◆ Ground Flute
- ◆ 3-Flat Round 1/2" Shank
- ◆ Gold Finish
- ◆ M35 Cobalt

- Cast Iron
- Steel
- Steel Forging
- Stainless Steel



**Titanium Jobber Drills - (TiN) Titanium Nitride Coating**

- ◆ Jobber Length
- ◆ 135° Split Point
- ◆ Ground Flute
- ◆ Straight Shank
- ◆ Heavy Duty Web
- ◆ TiN Coating

- ➔ Cast Iron
- ➔ Steel
- ➔ Tool Steel
- ➔ Alloys

Part #	Size	Dec.	OAL	Flute	Qty.	List	Part #	Size	Dec.	OAL	Flute	Qty.	List
255SP0464	1/16"	.0625	1-7/8"	7/8"	12	\$2.47	255SP1964	19/64"	.2969	4-3/8"	3-1/16"	12	\$8.47
255SP0564	5/64"	.0781	2"	1"	12	\$2.47	255SP2064	5/16"	.3125	4-1/2"	3-3/16"	12	\$8.63
255SP0664	3/32"	.0938	2-1/4"	1-1/4"	12	\$2.47	255SP2164	21/64"	.3281	4-5/8"	3-5/16"	6	\$8.98
255SP0764	7/64"	.1094	2-5/8"	1-1/2"	12	\$2.47	255SP2264	11/32"	.3438	4-3/4"	3-7/16"	6	\$9.28
255SP0864	1/8"	.1250	2-3/4"	1-5/8"	12	\$2.47	255SP2364	23/64"	.3594	4-7/8"	3-1/2"	6	\$12.65
255SP0964	9/64"	.1406	2-7/8"	1-3/4"	12	\$2.51	255SP2464	3/8"	.3750	5"	3-5/8"	6	\$13.14
255SP1064	5/32"	.1562	3-1/8"	2"	12	\$2.51	255SP2564	25/64"	.3906	5-1/8"	3-3/4"	6	\$15.98
255SP1164	11/64"	.1719	3-1/4"	2-1/8"	12	\$2.70	255SP2664	13/32"	.4062	5-1/4"	3-7/8"	6	\$16.23
255SP1264	3/16"	.1875	3-1/2"	2-5/16"	12	\$2.76	255SP2764	27/64"	.4219	5-3/8"	3-15/16"	6	\$16.85
255SP1364	13/64"	.2031	3-5/8"	2-7/16"	12	\$4.94	255SP2864	7/16"	.4375	5-1/2"	4-1/16"	6	\$17.50
255SP1464	7/32"	.2188	3-3/4"	2-1/2"	12	\$5.17	255SP2964	29/64"	.4531	5-5/8"	4-3/16"	6	\$18.11
255SP1564	15/64"	.2344	3-7/8"	2-5/8"	12	\$5.23	255SP3064	15/32"	.4688	5-3/4"	4-5/16"	6	\$18.62
255SP1664	1/4"	.2500	4"	2-3/4"	12	\$5.26	255SP3164	31/64"	.4844	5-7/8"	4-3/8"	6	\$19.06
255SP1764	17/64"	.2656	4-1/8"	2-7/8"	12	\$7.88	255SP3264	1/2"	.5000	6"	4-1/2"	6	\$19.28
255SP1864	9/32"	.2812	4-1/4"	2-15/16"	12	\$8.00							



Made In



**Spotweld - Double End - M42 COBALT**

Part #	Size	Frac.	OAL	Qty.	List
219DE0065	6.5 mm	1/4"	3-5/8"	5	\$21.99
219DE0080	8.0 mm	5/16"	3-5/8"	5	\$28.64
219DE0100	10.0 mm	3/8"	3-5/8"	5	\$42.83



**Double End - M42 COBALT**

Part #	Size	Dec.	OAL	Flute	Qty.	List
211CO0864	1/8"	.1250	2"	1/2"	12	\$5.35
211CO0030	#30	.1285	2"	1/2"	12	\$5.35

- ◆ Heavy Duty Spur
- ◆ M42 Super Cobalt
- ◆ High Red Hot Hardness
- ◆ Double End
- ◆ Gold Finish



**Double End - M2 HSS BRIGHT**

Part #	Size	Dec.	OAL	Flute	Qty.	List
211DE0764	7/64"	.1094	1-7/8"	1/2"	12	\$1.06
211DE0864	1/8"	.1250	2"	1/2"	12	\$1.14
211DE0964	9/64"	.1406	2"	1/2"	12	\$1.24
211DE1064	5/32"	.1562	2-1/16"	1/2"	12	\$1.38
211DE1264	3/16"	.1875	2-3/16"	1/2"	12	\$1.89
211DE1464	7/32"	.2188	2-3/8"	1/2"	12	\$2.72
211DE1664	1/4"	.2500	2-1/2"	1/2"	12	\$2.98
211DE0030	#30	.1285	2"	1/2"	12	\$1.20



**Double End - M2 HSS BLACK**

Part #	Size	Dec.	OAL	Flute	Qty.	List
211DE0864-B	1/8"	.1250	2"	1/2"	12	\$1.17
211DE0030-B	#30	.1285	2"	1/2"	12	\$1.24

- ◆ Heavy Duty
- ◆ 135° Split Point
- ◆ M2 HSS
- ◆ Bright and Black Finish

- ➔ Sheet Metal
- ➔ Automotive



### 6" Cobalt Aircraft - M35 COBALT

Part #	Size	Dec.	OAL	Flute	Qty.	List
212CO0464	1/16"	.0625	6"	7/8"	6	\$6.80
212CO0864	1/8"	.1250	6"	1-5/8"	6	\$6.72
212CO1064	5/32"	.1562	6"	2"	6	\$6.80
212CO1164	11/64"	.1719	6"	2-1/8"	6	\$8.17
212CO1264	3/16"	.1875	6"	2-5/16"	6	\$8.17
212CO1464	7/32"	.2188	6"	2-1/2"	6	\$10.16
212CO1664	1/4"	.2500	6"	2-3/4"	6	\$12.61
212CO2064	5/16"	.3125	6"	3-3/16"	1	\$24.53
212CO2464	3/8"	.3750	6"	3-5/8"	1	\$30.99

- ◆ Straight Shank
- ◆ 135° Split Point
- ◆ Ground Flute
- ◆ Extra Flexibility
- ◆ Heavy Duty Web
- ◆ Gold Finish
- ◆ M35 Cobalt



- Steel
- Stainless Steel
- Heat Treated Materials



### 6" Aircraft - M2 HSS

Part #	Size	Dec.	OAL	Flute	Qty.	List
212SP0464	1/16"	.0625	6"	7/8"	6	\$4.49
212SP0864	1/8"	.1250	6"	1-5/8"	6	\$4.49
212SP0964	9/64"	.1406	6"	1-3/4"	6	\$4.49
212SP1064	5/32"	.1562	6"	2"	6	\$4.49
212SP1164	11/64"	.1719	6"	2-1/8"	6	\$4.78
212SP1264	3/16"	.1875	6"	2-5/16"	6	\$5.13
212SP1364	13/64"	.2031	6"	2-7/16"	6	\$6.04
212SP1464	7/32"	.2188	6"	2-1/2"	6	\$6.36
212SP1564	15/64"	.2344	6"	2-5/8"	6	\$6.76
212SP1664	1/4"	.2500	6"	2-3/4"	6	\$7.88
212SP1764	17/64"	.2656	6"	2-7/8"	6	\$8.35
212SP1864	9/32"	.2812	6"	2-15/16"	6	\$9.08
212SP2064	5/16"	.3125	6"	3-3/16"	1	\$9.56
212SP2264	11/32"	.3438	6"	3-7/16"	1	\$12.31
212SP2464	3/8"	.3750	6"	3-5/8"	1	\$14.88
212SP2864	7/16"	.4375	6"	4-1/16"	1	\$18.44
212SP3264	1/2"	.5000	6"	4-1/2"	1	\$22.17

### 18" Aircraft - M2 HSS

Part #	Size	Dec.	OAL	Flute	Qty.	List
215SP1264	3/16"	.1875	18"	2-5/16"	1	\$17.13
215SP1664	1/4"	.2500	18"	2-3/4"	1	\$18.90
215SP2064	5/16"	.3125	18"	3-3/16"	1	\$33.50
215SP2464	3/8"	.3750	18"	3-5/8"	1	\$35.67
215SP3264	1/2"	.5000	18"	4-1/2"	1	\$49.47

### 6" Wire Gauge Aircraft - M2 HSS

Part #	Size	Dec.	OAL	Flute	Qty.	List
213SP0001	1	.2280	6"	2-5/8"	6	\$6.26
213SP0002	2	.2210	6"	2-5/8"	6	\$6.26
213SP0007	7	.2010	6"	2-7/16"	6	\$6.26
213SP0009	9	.1960	6"	2-7/16"	6	\$6.26
213SP0010	10	.1935	6"	2-7/16"	6	\$5.23
213SP0011	11	.1910	6"	2-5/16"	6	\$5.23
213SP0016	16	.1770	6"	2-3/16"	6	\$5.23
213SP0017	17	.1730	6"	2-3/16"	6	\$5.23
213SP0021	21	.1590	6"	2-1/8"	6	\$5.22
213SP0026	26	.1470	6"	1-7/8"	6	\$5.22
213SP0029	29	.1360	6"	1-3/4"	6	\$5.22
213SP0030	30	.1285	6"	1-5/8"	6	\$3.89
213SP0031	31	.1200	6"	1-5/8"	6	\$3.89
213SP0040	40	.0980	6"	1-3/8"	6	\$5.27

### 12" Aircraft - M2 HSS

Part #	Size	Dec.	OAL	Flute	Qty.	List
214SP0864	1/8"	.1250	12"	1-5/8"	1	\$6.33
214SP1064	5/32"	.1562	12"	2"	1	\$7.39
214SP1264	3/16"	.1875	12"	2-5/16"	1	\$11.67
214SP1464	7/32"	.2188	12"	2-1/2"	1	\$14.89
214SP1664	1/4"	.2500	12"	2-3/4"	1	\$16.33
214SP1864	9/32"	.2812	12"	2-15/16"	1	\$21.75
214SP2064	5/16"	.3125	12"	3-3/16"	1	\$23.39
214SP2264	11/32"	.3438	12"	3-7/16"	1	\$24.83
214SP2464	3/8"	.3750	12"	3-5/8"	1	\$26.94
214SP2864*	7/16"	.4375	12"	4-1/16"	1	\$35.83
214SP3264*	1/2"	.5000	12"	4-1/2"	1	\$43.39

\* 3/8" Shank

### 12" Wire Gauge Aircraft - M2 HSS

Part #	Size	Dec.	OAL	Flute	Qty.	List
213SP1201	1	.2280	12"	2-5/8"	1	\$17.95
213SP1207	7	.2010	12"	2-7/16"	1	\$13.78
213SP1210	10	.1935	12"	2-7/16"	1	\$13.78
213SP1221	21	.1590	12"	2-1/8"	1	\$10.48
213SP1229	29	.1360	12"	1-3/4"	1	\$7.00
213SP1230	30	.1285	12"	1-5/8"	1	\$7.00
213SP1231	31	.1200	12"	1-5/8"	1	\$7.00
213SP1240	40	.0980	12"	1-3/8"	1	\$7.60

- ◆ Straight Shank
- ◆ 135° Split Point
- ◆ Ground Flute
- ◆ Extra Flexibility
- ◆ Heavy Duty Web
- ◆ Black Oxide Finish
- ◆ M2 HSS

- Steel
- Medium Alloys

Long Boy - Full Body Spiral Drills P. 69





3-Flat, No-Slip Shank

Made in U.S.A.



Made In



Black & Gold

- ◆ Jobber Length
- ◆ 135° Split Point
- ◆ Ground Flute
- ◆ 3-Flat Shank
- ◆ Heavy Duty Web for Strength & Rigidity
- ◆ Black & Gold Finish
- ◆ M2 HSS

- Cast Iron
- Steel
- Steel Forging
- Stainless Steel

### MRO Black and Gold Jobber Drills - SUPER HEAVY DUTY

Part #	Size	Dec.	OAL	Flute	Qty.	List	Part #	Size	Dec.	OAL	Flute	Qty.	List
MRO-0464	1/16"	.0625	1-7/8"	7/8"	12	\$1.97	MRO-1964	19/64"	.2969	4-3/8"	3-1/16"	12	\$7.33
MRO-0564	5/64"	.0781	2"	1"	12	\$1.97	MRO-2064	5/16"	.3125	4-1/2"	3-3/16"	12	\$7.44
MRO-0664	3/32"	.0938	2-1/4"	1-1/4"	12	\$2.09	MRO-2164	21/64"	.3281	4-5/8"	3-5/16"	6	\$8.33
MRO-0764	7/64"	.1094	2-5/8"	1-1/2"	12	\$2.15	MRO-2264	11/32"	.3438	4-3/4"	3-7/16"	6	\$9.40
MRO-0864	1/8"	.1250	2-3/4"	1-5/8"	12	\$2.27	MRO-2364	23/64"	.3594	4-7/8"	3-1/2"	6	\$10.58
MRO-0964	9/64"	.1406	2-7/8"	1-3/4"	12	\$2.45	MRO-2464	3/8"	.3750	5"	3-5/8"	6	\$10.65
MRO-1064	5/32"	.1562	3-1/8"	2"	12	\$2.69	MRO-2564	25/64"	.3906	5-1/8"	3-3/4"	6	\$12.97
MRO-1164	11/64"	.1719	3-1/4"	2-1/8"	12	\$2.93	MRO-2664	13/32"	.4062	5-1/4"	3-7/8"	6	\$13.27
MRO-1264	3/16"	.1875	3-1/2"	2-5/16"	12	\$3.53	MRO-2764	27/64"	.4219	5-3/8"	3-15/16"	6	\$14.69
MRO-1364	13/64"	.2031	3-5/8"	2-7/16"	12	\$4.04	MRO-2864	7/16"	.4375	5-1/2"	4-1/16"	6	\$15.71
MRO-1464	7/32"	.2188	3-3/4"	2-1/2"	12	\$4.08	MRO-2964	29/64"	.4531	5-5/8"	4-3/16"	6	\$18.33
MRO-1564	15/64"	.2344	3-7/8"	2-5/8"	12	\$4.42	MRO-3064	15/32"	.4688	5-3/4"	4-5/16"	6	\$18.51
MRO-1664	1/4"	.2500	4"	2-3/4"	12	\$4.85	MRO-3164	31/64"	.4844	5-7/8"	4-3/8"	6	\$19.31
MRO-1764	17/64"	.2656	4-1/8"	2-7/8"	12	\$5.83	MRO-3264	1/2"	.5000	6"	4-1/2"	6	\$19.56
MRO-1864	9/32"	.2812	4-1/4"	2-15/16"	12	\$6.78							

### MRO Black & Gold Letter Drills - SUPER HEAVY DUTY

Part #	Size	Dec.	OAL	Flute	Qty.	List	Part #	Size	Dec.	OAL	Flute	Qty.	List
MRO-A	A	.234	3-7/8"	2-5/8"	12	\$6.06	MRO-N	N	.302	4-3/8"	3-1/16"	6	\$10.06
MRO-B	B	.238	4"	2-3/4"	12	\$6.06	MRO-O	O	.316	4-1/2"	3-3/16"	6	\$10.20
MRO-C	C	.242	4"	2-3/4"	12	\$5.84	MRO-P	P	.323	4-5/8"	3-5/16"	6	\$10.38
MRO-D	D	.246	4"	2-3/4"	12	\$5.84	MRO-Q	Q	.332	4-3/4"	3-7/16"	6	\$10.38
MRO-E	E	.250	4"	2-3/4"	12	\$5.85	MRO-R	R	.339	4-3/4"	3-7/16"	6	\$10.47
MRO-F	F	.257	4-1/8"	2-7/8"	12	\$6.42	MRO-S	S	.348	4-7/8"	3-1/2"	6	\$12.24
MRO-G	G	.261	4-1/8"	2-7/8"	12	\$6.69	MRO-T	T	.358	4-7/8"	3-1/2"	6	\$12.24
MRO-H	H	.266	4-1/8"	2-7/8"	12	\$7.00	MRO-U	U	.368	5"	3-5/8"	6	\$13.06
MRO-I	I	.272	4-1/8"	2-7/8"	12	\$7.04	MRO-V	V	.377	5"	3-5/8"	6	\$13.16
MRO-J	J	.277	4-1/8"	2-7/8"	12	\$8.25	MRO-W	W	.386	5-1/8"	3-3/4"	6	\$13.98
MRO-K	K	.281	4-1/4"	2-15/16"	12	\$8.25	MRO-X	X	.397	5-1/8"	3-3/4"	6	\$16.64
MRO-L	L	.290	4-1/4"	2-15/16"	6	\$9.48	MRO-Y	Y	.404	5-1/4"	3-7/8"	6	\$18.31
MRO-M	M	.295	4-3/8"	3-1/16"	6	\$10.06	MRO-Z	Z	.413	5-1/4"	3-7/8"	6	\$19.22



**Made In**



- ◆ 135° Split Point
- ◆ Ground Flute
- ◆ 3-Flat Shank on #1-12
- ◆ Heavy Duty Web for Strength & Rigidity
- ◆ Black & Gold Finish
- ◆ M2 HSS

- Cast Iron
- Steel
- Steel Forging
- Stainless Steel



**NOTE:**  
SIZES 40 → 60  
HAVE NO  
SPLIT POINT.

## MRO Black & Gold Wire Gauge Drills - SUPER HEAVY DUTY

Part #	Size	Dec.	OAL	Flute	Qty.	List	Part #	Size	Dec.	OAL	Flute	Qty.	List
MRO-01	1	.2280	3-7/8"	2-5/8"	12	\$5.44	MRO-21	21	.1590	3-1/4"	2-1/8"	12	\$3.19
MRO-02	2	.2210	3-7/8"	2-5/8"	12	\$5.14	MRO-22	22	.1570	3-1/8"	2"	12	\$3.27
MRO-03	3	.2130	3-3/4"	2-1/2"	12	\$5.11	MRO-23	23	.1540	3-1/8"	2"	12	\$3.20
MRO-04	4	.2090	3-3/4"	2-1/2"	12	\$5.11	MRO-24	24	.1520	3-1/8"	2"	12	\$3.17
MRO-05	5	.2055	3-3/4"	2-1/2"	12	\$5.14	MRO-25	25	.1495	3"	1-7/8"	12	\$2.97
MRO-06	6	.2040	3-3/4"	2-1/2"	12	\$5.14	MRO-26	26	.1470	3"	1-7/8"	12	\$3.00
MRO-07	7	.2010	3-5/8"	2-7/16"	12	\$4.41	MRO-27	27	.1440	3"	1-7/8"	12	\$2.85
MRO-08	8	.1990	3-5/8"	2-7/16"	12	\$4.50	MRO-28	28	.1405	2-7/8"	1-3/4"	12	\$2.84
MRO-09	9	.1960	3-5/8"	2-7/16"	12	\$4.50	MRO-29	29	.1360	2-7/8"	1-3/4"	12	\$2.80
MRO-10	10	.1935	3-5/8"	2-7/16"	12	\$4.37	MRO-30	30	.1285	2-3/4"	1-5/8"	12	\$2.80
MRO-11	11	.1910	3-1/2"	2-5/16"	12	\$4.29	MRO-31	31	.1200	2-3/4"	1-5/8"	12	\$2.51
MRO-12	12	.1890	3-1/2"	2-5/16"	12	\$4.30	MRO-32	32	.1160	2-3/4"	1-5/8"	12	\$2.51
MRO-13	13	.1850	3-1/2"	2-5/16"	12	\$4.06	MRO-33	33	.1130	2-5/8"	1-1/2"	12	\$2.52
MRO-14	14	.1820	3-3/8"	2-3/16"	12	\$4.08	MRO-34	34	.1110	2-5/8"	1-1/2"	12	\$2.52
MRO-15	15	.1800	3-3/8"	2-3/16"	12	\$4.06	MRO-35	35	.1100	2-5/8"	1-1/2"	12	\$2.51
MRO-16	16	.1770	3-3/8"	2-3/16"	12	\$3.98	MRO-36	36	.1065	2-1/2"	1-7/16"	12	\$2.43
MRO-17	17	.1730	3-3/8"	2-3/16"	12	\$3.77	MRO-37	37	.1040	2-1/2"	1-7/16"	12	\$2.45
MRO-18	18	.1695	3-1/4"	2-1/8"	12	\$3.48	MRO-38	38	.1015	2-1/2"	1-7/16"	12	\$2.44
MRO-19	19	.1660	3-1/4"	2-1/8"	12	\$3.48	MRO-39	39	.0995	2-3/8"	1-3/8"	12	\$2.42
MRO-20	20	.1610	3-1/4"	2-1/8"	12	\$3.46	MRO-40	40	.0980	2-3/8"	1-3/8"	12	\$2.41

\*\*Sizes 41-60 are available upon request.



# MRO

MADE IN USA



Made In



Black & Gold

- ◆ Jobber Length
- ◆ 135° Split Point
- ◆ Ground Flute
- ◆ Straight Shank
- ◆ Heavy Duty Web
- ◆ Black & Gold Finish
- ◆ M2 HSS
- Cast Iron
- Steel
- Steel Forging
- Stainless Steel



Parabolic Jobber Drills - SUPER HEAVY DUTY - M2 HSS

Part #	Size	Dec.	OAL	Flute	Qty.	List	Part #	Size	Dec.	OAL	Flute	Qty.	List
PB-0464	1/16"	.0625	1-7/8"	7/8"	12	\$2.28	PB-1964	19/64"	.2969	4-3/8"	3-1/16"	12	\$6.83
PB-0564	5/64"	.0781	2"	1"	12	\$2.28	PB-2064	5/16"	.3125	4-1/2"	3-3/16"	12	\$7.12
PB-0664	3/32"	.0938	2-1/4"	1-1/4"	12	\$2.28	PB-2164	21/64"	.3281	4-5/8"	3-5/16"	6	\$8.12
PB-0764	7/64"	.1094	2-5/8"	1-1/2"	12	\$2.51	PB-2264	11/32"	.3438	4-3/4"	3-7/16"	6	\$8.82
PB-0864	1/8"	.1250	2-3/4"	1-5/8"	12	\$2.51	PB-2364	23/64"	.3594	4-7/8"	3-1/2"	6	\$10.04
PB-0964	9/64"	.1406	2-7/8"	1-3/4"	12	\$2.63	PB-2464	3/8"	.3750	5"	3-5/8"	6	\$10.22
PB-1064	5/32"	.1562	3-1/8"	2"	12	\$2.63	PB-2564	25/64"	.3906	5-1/8"	3-3/4"	6	\$12.58
PB-1164	11/64"	.1719	3-1/4"	2-1/8"	12	\$2.80	PB-2664	13/32"	.4062	5-1/4"	3-7/8"	6	\$12.70
PB-1264	3/16"	.1875	3-1/2"	2-5/16"	12	\$3.10	PB-2764	27/64"	.4219	5-3/8"	3-15/16"	6	\$14.61
PB-1364	13/64"	.2031	3-5/8"	2-7/16"	12	\$3.39	PB-2864	7/16"	.4375	5-1/2"	4-1/16"	6	\$14.92
PB-1464	7/32"	.2188	3-3/4"	2-1/2"	12	\$4.03	PB-2964	29/64"	.4531	5-5/8"	4-3/16"	6	\$17.14
PB-1564	15/64"	.2344	3-7/8"	2-5/8"	12	\$4.38	PB-3064	15/32"	.4688	5-3/4"	4-5/16"	6	\$17.69
PB-1664	1/4"	.2500	4"	2-3/4"	12	\$4.50	PB-3164	31/64"	.4844	5-7/8"	4-3/8"	6	\$18.99
PB-1764	17/64"	.2656	4-1/8"	2-7/8"	12	\$5.61	PB-3264	1/2"	.5000	6"	4-1/2"	6	\$19.23
PB-1864	9/32"	.2812	4-1/4"	2-15/16"	12	\$6.37							

Extra Heavy Duty Web

30% thicker than even heavy duty webs, resists the extra shear stress found in deep hole drilling.

Parabolic Flute

Fast parabolic spiral allows deep hole drilling without frequent drill removal to clear chips.

Made In



- ◆ Jobber Length
- ◆ 135° Split Point
- ◆ Ground Flute
- ◆ Straight Shank
- ◆ Heavy Duty Web
- ◆ Gold Finish
- ◆ M42 Super Cobalt
- Hardened Steel
- Stainless Steel
- High Temp Alloys
- Heat Treated Materials
- Abrasive Plastics



Cobalt Jobber Drills - SUPER HEAVY DUTY - M42 SUPER COBALT

Part #	Size	Dec.	OAL	Flute	Qty.	List	Part #	Size	Dec.	OAL	Flute	Qty.	List
CO-0464	1/16"	.0625	1-7/8"	7/8"	12	\$3.01	CO-1964	19/64"	.2969	4-3/8"	3-1/16"	12	\$11.17
CO-0564	5/64"	.0781	2"	1"	12	\$3.01	CO-2064	5/16"	.3125	4-1/2"	3-3/16"	12	\$11.47
CO-0664	3/32"	.0938	2-1/4"	1-1/4"	12	\$3.01	CO-2164	21/64"	.3281	4-5/8"	3-5/16"	6	\$13.38
CO-0764	7/64"	.1094	2-5/8"	1-1/2"	12	\$3.12	CO-2264	11/32"	.3438	4-3/4"	3-7/16"	6	\$14.63
CO-0864	1/8"	.1250	2-3/4"	1-5/8"	12	\$3.53	CO-2364	23/64"	.3594	4-7/8"	3-1/2"	6	\$14.69
CO-0964	9/64"	.1406	2-7/8"	1-3/4"	12	\$3.97	CO-2464	3/8"	.3750	5"	3-5/8"	6	\$14.74
CO-1064	5/32"	.1562	3-1/8"	2"	12	\$4.08	CO-2564	25/64"	.3906	5-1/8"	3-3/4"	6	\$17.69
CO-1164	11/64"	.1719	3-1/4"	2-1/8"	12	\$4.25	CO-2664	13/32"	.4062	5-1/4"	3-7/8"	6	\$19.90
CO-1264	3/16"	.1875	3-1/2"	2-5/16"	12	\$4.91	CO-2764	27/64"	.4219	5-3/8"	3-15/16"	6	\$22.45
CO-1364	13/64"	.2031	3-5/8"	2-7/16"	12	\$6.18	CO-2864	7/16"	.4375	5-1/2"	4-1/16"	6	\$22.96
CO-1464	7/32"	.2188	3-3/4"	2-1/2"	12	\$6.35	CO-2964	29/64"	.4531	5-5/8"	4-3/16"	6	\$26.31
CO-1564	15/64"	.2344	3-7/8"	2-5/8"	12	\$7.20	CO-3064	15/32"	.4688	5-3/4"	4-5/16"	6	\$27.05
CO-1664	1/4"	.2500	4"	2-3/4"	12	\$7.17	CO-3164	31/64"	.4844	5-7/8"	4-3/8"	6	\$28.75
CO-1764	17/64"	.2656	4-1/8"	2-7/8"	12	\$8.51	CO-3264	1/2"	.5000	6"	4-1/2"	6	\$29.03
CO-1864	9/32"	.2812	4-1/4"	2-15/16"	12	\$9.13							

## 29 PC Jobber Sets - Bullet Case

Part #	Set	Sizes	Type	Drills	Point	List
BG-1	29 pc	1/16" → 1/2" x 64ths	BLACK & GOLD	p. 17	135° S.P.	\$142.28
BX-1	29 pc	1/16" → 1/2" x 64ths	BLACK OXIDE	p. 12	135° S.P.	\$124.52
CX-1	29 pc	1/16" → 1/2" x 64ths	COBALT	p. 20	135° S.P.	\$236.78
TI-1	29 pc	1/16" → 1/2" x 64ths	TITANIUM	p. 22	135° S.P.	\$215.89
BT-1	29 pc	1/16" → 1/2" x 64ths	BRIGHT	p. 10	118°	\$142.70
MC-1	29 pc	1/16" → 1/2" x 64ths	MECHANICS 3-FLAT*	p. 18	135° S.P.	\$181.60
MRO-1F	29 pc	1/16" → 1/2" x 64ths	MRO 3-FLAT*	p. 24	135° S.P.	\$231.99
PB-1	29 pc	1/16" → 1/2" x 64ths	PARABOLIC*	p. 26	135° S.P.	\$237.03
CO-1	29 pc	1/16" → 1/2" x 64ths	COBALT*	p. 26	135° S.P.	\$344.92

◆ Huot Bullet Case

\* Made in USA

S.P. = Split Point





### 13 PC Jobber Sets - Straight Shank

Part #	Set	Sizes	Type	Drills	Point	List
AD-13	13 pc	1/16" → 1/4" x 64ths	Black Oxide	p.11	118°	\$15.91
BT-13	13 pc	1/16" → 1/4" x 64ths	Bright Finish	p.10	118°	\$24.17
SP-13	13 pc	1/16" → 1/4" x 64ths	Black Oxide	p.12	135° S.P.	\$23.06
BG-13	13 pc	1/16" → 1/4" x 64ths	Black & Gold	p.17	135° S.P.	\$29.90
CX-13	13 pc	1/16" → 1/4" x 64ths	Cobalt	p.20	135° S.P.	\$40.83
CO-13	13 pc	1/16" → 1/4" x 64ths	Cobalt*	p.26	135° S.P.	\$51.84
TI-13	13 pc	1/16" → 1/4" x 64ths	Titanium	p.22	135° S.P.	\$46.78
MRO-13F	13 pc	1/16" → 1/4" x 64ths	MRO 3-FLAT*	p.24	135° S.P.	\$49.68
PB-13	13 pc	1/16" → 1/4" x 64ths	Parabolic*	p.26	135° S.P.	\$39.78

◆ Metal Huot Case

\* Made in USA

S.P. = Split Point



### 15 PC Jobber Sets - Straight Shank

Part #	Set	Sizes	Type	Drills	Point	List
SP-15	15 pc	1/16" → 1/2" x 32nds	Black Oxide	p.12	135° S.P.	\$74.02
BG-15	15 pc	1/16" → 1/2" x 32nds	Black & Gold	p.17	135° S.P.	\$82.45
CX-15	15 pc	1/16" → 1/2" x 32nds	Cobalt	p.20	135° S.P.	\$131.79
CO-15	15 pc	1/16" → 1/2" x 32nds	Cobalt*	p.26	135° S.P.	\$151.93
MRO-15F	15 pc	1/16" → 1/2" x 32nds	MRO 3-FLAT*	p.24	135° S.P.	\$133.15
PB-15	15 pc	1/16" → 1/2" x 32nds	Parabolic*	p.26	135° S.P.	\$102.46

◆ Metal Huot Case

\* Made in USA

S.P. = Split Point



### 29 PC Jobber Sets - Straight Shank

Part #	Set	Sizes	Type	Drills	Point	List
AD-29	29 pc	1/16" → 1/2" x 64ths	Black Oxide	p.11	118°	\$77.87
BT-29	29 pc	1/16" → 1/2" x 64ths	Bright Finish	p.10	118°	\$137.17
SP-29	29 pc	1/16" → 1/2" x 64ths	Black Oxide	p.12	135° S.P.	\$124.52
BG-29	29 pc	1/16" → 1/2" x 64ths	Black & Gold	p.17	135° S.P.	\$162.88
CX-29	29 pc	1/16" → 1/2" x 64ths	Cobalt	p.20	135° S.P.	\$246.05
CO-29	29 pc	1/16" → 1/2" x 64ths	Cobalt*	p.26	135° S.P.	\$286.18
TI-29	29 pc	1/16" → 1/2" x 64ths	Titanium	p.22	135° S.P.	\$267.39
MRO-29F	29 pc	1/16" → 1/2" x 64ths	MRO 3-FLAT*	p.24	135° S.P.	\$234.42
PB-29	29 pc	1/16" → 1/2" x 64ths	Parabolic*	p.26	135° S.P.	\$179.10

◆ Metal Huot Case

\* Made in USA

S.P. = Split Point

## 29 PC Jobber Sets - 3/8" Shank

Part #	Set	Sizes	Type	Drills	Point	List
SP-29R	29 pc	1/16" → 1/2" x 64ths	Black Oxide	p.13	135° S.P.	\$162.55
BG-29R	29 pc	1/16" → 1/2" x 64ths	Black & Gold	p.18	135° S.P.	\$183.59
CX-29R	29 pc	1/16" → 1/2" x 64ths	Cobalt	p.21	135° S.P.	\$277.71

1/16" - 3/8" STRAIGHT SHANK, 25/64" - 1/2" WITH 3/8" SHANK

S.P. = Split Point

◆ Metal Huot Case



## 8 PC Silver & Deming Sets

Part #	Set	Sizes	Type	Drills	Point	List
AD-8	8 pc	See Below	Black Oxide	p.15	118°	\$190.77
BG-8	8 pc	See Below	Black & Gold	p.19	118°	\$258.94
CX-8	8 pc	See Below	Cobalt	p.21	135° S.P.	\$530.51

ALL SETS: 9/16", 5/8", 11/16", 3/4", 13/16", 7/8", 15/16", 1"

S.P. = Split Point

◆ Metal Huot Case



## 60 PC Wire Gauge Sets

Part #	Set	Sizes	Type	Drills	Point	List
SP-60	60 pc	#1 → #60	Black Oxide	p.12	135° S.P.	\$90.27
BG-60	60 pc	#1 → #60	Black & Gold	p.17	135° S.P.	\$96.17
CX-60	60 pc	#1 → #60	Cobalt	p.20	135° S.P.	\$194.95

S.P. = Split Point

◆ Metal Huot Case





### LETTER A → Z Sets - Straight Shank

Part #	Set	Sizes	Type	Drills	Point	List
SP-AZ	26 pc	A → Z	Black Oxide	p.13	135° S.P.	\$151.37
BG-AZ	26 pc	A → Z	Black & Gold	p.19	135° S.P.	\$161.74

◆ Metal Huot Case

S.P. = Split Point



### 115 PC MASTER Sets - Straight Shank

Part #	Set	Sizes	Type	Drills	Point	List
SP-115	115 pc	See Below	Black Oxide	p.12	135° S.P.	\$376.98
BG-115	115 pc	See Below	Black & Gold	p.17	135° S.P.	\$431.61
CX-115	115 pc	See Below	Cobalt	p.20	135° S.P.	\$731.75

JOBBER SIZES: 1/16" → 1/2", WIRE GAUGE DRILL SIZES #1 → #60,  
LETTER SIZES: A → Z. STRAIGHT SHANK.

◆ Metal Huot Case

S.P. = Split Point



### METRIC Sets - Straight Shank

Part #	Set	Sizes	Type	Drills	Point	List
MM-11	11 pc	1.00MM → 6.00MM	Black Oxide	p.13	118°	\$24.57
MM-25	25 pc	1.00MM → 13.00MM	Black Oxide	p.13	118°	\$122.15

◆ Metal Huot Case



### TAP & DRILL Sets - CARBON / HSS TAPS

Part #	Sizes	Type	Drills	Point	List
CD-SP-019	See Below	Carbon Taps	p.11	118°	\$58.41
TD-SP-019	See Below	HSS Taps	p.12	135° S.P.	\$81.93

HSS DRILL BIT SIZES: #36, #29, #25, #21, #7, F, 5/16", U, 27/64"  
TAP SIZES: 6-32, 8-32, 10-24, 10-32, 1/4"-20, 5/16"-18, 3/8"-16, 7/16"-14, 1/2"-13

◆ Metal Huot Case

**525 Pc. Dispenser Contains:**

24- 1/16"	24- 5/64"	48- 3/32"	24- 7/64"	72- 1/8"
24- 9/64"	36- 5/32"	24- 11/64"	48- 3/16"	24- 13/64"
24- 7/32"	12- 15/64"	60- 1/4"	3- 17/64"	12- 9/32"
3- 19/64"	12- 5/16"	3- 21/64"	3- 11/32"	3- 23/64"
12- 3/8"	3- 25/64"	3- 13/32"	3- 27/64"	6- 7/16"
3- 29/64"	3- 15/32"	3- 31/64"	6- 1/2"	

This attractive drill bit merchandiser puts all 29 essential jobber sizes at your fingertips. Made of heavy duty steel construction, this deep red cabinet dispenser fits perfectly on any counter top. Comes with lock and key.



**525 PC Jobber Countertop Dispenser**

Part #	Set	Sizes	Type	Drills	Point	List
SP-525	525 pc	1/16" → 1/2" x 64ths	Black Oxide	p.12	135° S.P.	\$1040.86
BG-525	525 pc	1/16" → 1/2" x 64ths	Black & Gold	p.17	135° S.P.	\$1498.34
MC-525	525 pc	1/16" → 1/2" x 64ths	Mechanics*	p.18	135° S.P.	\$2324.97
CX-525	525 pc	1/16" → 1/2" x 64ths	Cobalt	p.20	135° S.P.	\$1950.98
MRO-525	525 pc	1/16" → 1/2" x 64ths	MRO 3-FLAT*	p.24	135° S.P.	\$2431.83

S.P. = Split Point

\* Made in USA

◆ Metal Huot Case

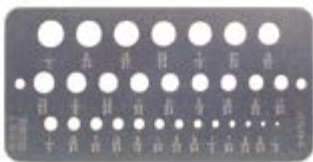

**Metal Drill Gauges**

Part #	Description	Sizes	List
29GAUGE	29 Hole Gauge	1/16" → 1/2"	\$12.05
60GAUGE	60 Hole Gauge	#1 → #60 Wire	\$14.34





### Single (1) Flute Counter Sinks - HSS

- ◆ HSS
- ◆ Milled Body
- ◆ Ground Flute
- Iron
- Steel
- Plastic
- Light to Medium Metals

60° Part #	82° Part #	90° Part #	100° Part #	Size	Shank Diameter	Shank Length	OAL	List
CI-60-1264	CI-82-1264	CI-90-1264	CI-100-1264	3/16"	3/16"	3/4"	1-1/2"	\$10.00
CI-60-1664	CI-82-1664	CI-90-1664	CI-100-1664	1/4"	1/4"	3/4"	2"	\$10.21
CI-60-2064	CI-82-2064	CI-90-2064	CI-100-2064	5/16"	1/4"	1"	2"	\$11.94
CI-60-2464	CI-82-2464	CI-90-2464	CI-100-2464	3/8"	1/4"	1"	2"	\$14.17
CI-60-3264	CI-82-3264	CI-90-3264	CI-100-3264	1/2"	1/4"	1"	2"	\$17.64
CI-60-4064	CI-82-4064	CI-90-4064	CI-100-4064	5/8"	3/8"	1-1/8"	2-3/4"	\$27.08
CI-60-4864	CI-82-4864	CI-90-4864	CI-100-4864	3/4"	3/8"	1-5/16"	2-3/4"	\$30.35
CI-60-5064	CI-82-5064	CI-90-5064	CI-100-5064	7/8"	1/2"	1-5/16"	2-3/4"	\$48.26
CI-60-6464	CI-82-6464	CI-90-6464	CI-100-6464	1"	1/2"	1-5/16"	2-3/4"	\$53.61



### Three (3) Flute Counter Sinks - HSS

60° Part #	82° Part #	90° Part #	100° Part #	Size	Shank Diameter	Shank Length	OAL	List
R3-60-1664	R3-82-1664	R3-90-1664	R3-100-1664	1/4"	3/16"	3/4"	1-1/2"	\$10.21
R3-60-2464	R3-82-2464	R3-90-2464	R3-100-2464	3/8"	1/4"	7/8"	2-3/4"	\$14.17
R3-60-3264	R3-82-3264	R3-90-3264	R3-100-3264	1/2"	3/8"	1"	2"	\$17.64
R3-60-4064	R3-82-4064	R3-90-4064	R3-100-4064	5/8"	3/8"	1"	2-1/4"	\$27.08
R3-60-4864	R3-82-4864	R3-90-4864	R3-100-4864	3/4"	1/2"	1-1/4"	2-5/8"	\$30.35
R3-60-6464	R3-82-6464	R3-90-6464	R3-100-6464	1"	1/2"	1-1/4"	2-3/4"	\$53.61



CARDED

**Part # SE-006-16**  
**6 Pc. Screw Extractor Set**  
 #1, #2, #3, #4, #5, #6  
**Price Each \$23.10**



### Screw Extractor - LEFT HAND SPIRAL FLUTE

Part #	Size	Shank Diameter	Removes Screws or	Pipe	List
SE0001	1	5/64"	3/32" to 5/32"		\$1.92
SE0002	2	7/64"	5/32" to 7/32"		\$2.28
SE0003	3	5/32"	7/32" to 9/32"		\$2.80
SE0004	4	1/4"	9/32" to 3/8"	1/8" Pipe	\$3.50
SE0005	5	19/64"	3/8" to 5/8"	1/4" Pipe	\$4.62
SE0006	6	13/32"	5/8" to 7/8"	3/8" Pipe	\$8.22
SE0007	7	17/32"	7/8" to 1-1/8"	1/2" Pipe	\$12.83
SE0008	8	13/16"	1-1/8" to 1-3/8"	3/4" Pipe	\$23.93
SE0009	9	1-1/16"	1-3/8" to 2"	1" Pipe	\$34.85

**TAPER**  
 8 to 10 threads chamfered for easy thread starting in tough material.

**PLUG**  
 3 to 5 threads chamfered for general use when tapping to bottom of hole is not critical. **This is the most popular tap of all three styles.**

**BOTTOM**  
 1-1/2 threads chamfered for use after threads have been started. Used for clean tapping to bottom of holes.

**NC = National Course**  
**NF = National Fine**



**Packaging:**  
**Sizes**  
**0-80 → 1/2"-20**  
**5 / box**

**Sold Individually**  
**over 1/2"-20.**

DRILL THIS SIZE HOLE			TO TAP FOR THIS BOLT OR SCREW
DECIMAL INCHES	DRILL SIZE	NEAREST FRACTION	
.0469"	3/64"	3/64"	0-80 NF
.0595"	No. 53	none	1-64 NC
.0595"	No. 53	1/16"	1-72 NF
.0700"	No. 50	none	2-56 NC
.0700"	No. 50	none	2-64 NF
.0785"	No. 47	5/64"	3-48 NC
.0820"	No. 45	none	3-56 NF
.0860"	No. 44	none	4-36 NS
.0890"	No. 43	3/32"	4-40 NC
.0935"	No. 42	3/32"	4-48 NF
.0984"	2.5mm	none	3mm-0.60mm
.1015"	No. 38	none	1/8-40 NS
.1015"	No. 38	none	5-40 NC
.1040"	No. 37	none	5-44 NF
.1100"	No. 35	7/64"	6-32 NC
.1110"	No. 34	none	6-36 NS
.1130"	No. 33	none	6-40 NF
.1200"	No. 31	none	6-48 NS
.1338"	3.4mm	none	4mm-0.70mm
.1338"	3.4mm	none	4mm-0.75mm
.1360"	No. 29	none	8-32 NC
.1360"	No. 29	9/64"	8-36 NF
.1405"	No. 28	none	8-40 NS
.1470"	No. 26	none	3/16-24 NS
.1495"	No. 25	5/32"	10-24 NC
.1570"	No. 22	none	3/16-32 NS
.1590"	No. 21	5/32"	10-32 NF
.1653"	4.2mm	none	5mm-0.90mm
.1693"	4.3mm	none	5mm-0.80mm
.1770"	No. 16	11/64"	12-24 NC
.1820"	No. 14	3/16"	12-28 NF
.1850"	No. 13	none	12-32 NEF
.1935"	No. 10	none	14-20 NS
.2010"	No. 7	13/64"	1/4-20 NC
.2010"	No. 7	none	14-24 NS
.2047"	5.2mm	none	6mm-1.00mm
.2090"	No. 4	none	1/4-24 NS
.2130"	No. 3	7/32"	1/4-28 NF
.2188"	7/32"	7/32"	1/4-32 NEF
.2280"	No. 1	none	1/4-40 NS
.2401"	6.1mm	15/64"	7mm-1.00mm
.2570"	Ltr. F	17/64"	5/16-18 NC
.2716"	6.9mm	17/64"	8mm-1.25mm
.2720"	Ltr. I	none	5/16-24 NF
.2795"	7.1mm	none	8mm-1.00mm
.2812"	9/32"	9/32"	5/16-32 NEF
.3110"	7.9mm	none	9mm-1.25mm
.3125"	5/16"	5/16"	3/8-16 NC

DRILL THIS SIZE HOLE			TO TAP FOR THIS BOLT OR SCREW
DECIMAL INCHES	DRILL SIZE	NEAREST FRACTION	
.3189"	8.1mm	none	9mm-1.00mm
.3268"	8.3mm	none	9mm-0.75mm
.3320"	Ltr. Q	21/64"	3/8-24 NF
.3425"	8.7mm	none	10mm-1.50mm
.3503"	8.9mm	11/32"	10mm-1.25mm
.3583"	9.1mm	none	*10mm-1.00mm
.3680"	Ltr. U	23/64"	7/16"-14 NC
.3818"	9.7mm	none	11mm-1.50mm
.3906"	25/64"	25/64"	7/16-20 NF
.4133"	10.5mm	none	12mm-1.75mm
.4212"	10.7mm	27/64"	12mm-1.50mm
.4219"	27/64"	27/64"	1/2-13 NC
.4291"	10.9mm	27/64"	*12mm-1.25mm
.4531"	29/64"	29/64"	1/2-20 NF
.4531"	29/64"	29/64"	1/2-24 NS
.4803"	12.2mm	none	14mm-2.00mm
.4844"	31/64"	31/64"	9/16-12 NC
.4999"	12.7mm	none	14mm-1.50mm
.5039"	12.8mm	none	*14mm-1.25mm
.5156"	33/64"	33/64"	9/16-18 NF
.5312"	17/32"	17/32"	5/8-11 NC
.5590"	14.2mm	35/64"	16mm-2.00mm
.5781"	37/64"	37/64"	5/8-18 NF
.5787"	14.7mm	none	16mm-1.50mm
.5938"	19/32"	19/32"	11/16-11 NS
.6220"	15.8mm	39/64"	18mm-2.50mm
.6250"	5/8"	5/8"	11/16-16 NS
.6562"	21/32"	21/32"	3/4-10 NC
.6614"	16.8mm	none	*18mm-1.50mm
.6875"	11/16"	11/16"	3/4-16 NF
.7008"	17.8mm	11/16"	20mm-2.50mm
.7656"	49/64"	49/64"	7/8-9 NC
.8125"	13/16"	13/16"	7/8-14 NF
.8228"	20.9mm	none	22mm-1.50mm
.8281"	53/64"	53/64"	*7/8-18 NS
.8425"	21.4mm	53/64"	24mm-3.00mm
.8750"	7/8"	7/8"	1-8 NC
.8779"	22.3mm	none	24mm-2.00mm
.9219"	59/64"	59/64"	1-12 NF
.9375"	15/16"	15/16"	1-14 NS
.9844"	63/64"	63/64"	1-1/8 - 7 NC
1.0469"	1-3/64"	1-3/64"	1-1/8 - 12 NF
1.1094"	1-7/64"	1-7/64"	1-1/4 - 7 NC
1.1719"	1-11/64"	1-11/64"	1-1/4 - 12 NF
1.2188"	1-7/32"	1-7/32"	1-3/8 - 6 NC
1.2969"	1-19/64"	1-19/64"	1-3/8 - 12 NF
1.3468"	1-11/32"	1-11/32"	1-1/2 - 6 NC
1.4219"	1-27/64"	1-27/64"	1-1/2 - 12 NF

\* Spark Plug Taps.



NPT Tap-Drill Chart  
 Available on Page 36.



**Carbon Steel Hand Taps - MACHINE SCREW**

PART #			Machine Screw Thread	No. Of Flutes	Ground Thread Limit	OAL	Use Thread Length	Drill Size	List
TAPER	PLUG	BOTTOM							
C62NC0004	C63NC0004	C64NC0004	<b>4-40 NC</b>	3	H2	1-7/8"	9/16"	43	\$2.48
C62NF0004	C63NF0004	C64NF0004	<b>4-48 NF</b>	3	H2	1-7/8"	9/16"	42	\$2.48
C62NC0005	C63NC0005	C64NC0005	<b>5-40 NC</b>	3	H2	1-15/16"	7/8"	38	\$2.48
C62NF0005	C63NF0005	C64NF0005	<b>5-44 NF</b>	3	H2	1-15/16"	7/8"	37	\$2.48
C62NC0006	C63NC0006	C64NC0006	<b>6-32 NC</b>	3	H2	2"	11/16"	35	\$2.48
C62NF0006	C63NF0006	C64NF0006	<b>6-40 NF</b>	3	H2	2"	11/16"	33	\$2.48
C62NC0008	C63NC0008	C64NC0008	<b>8-32 NC</b>	4	H3	2-1/8"	3/4"	29	\$2.60
C62NF0008	C63NF0008	C64NF0008	<b>8-36 NF</b>	4	H3	2-1/8"	3/4"	29	\$2.60
C62NC0010	C63NC0010	C64NC0010	<b>10-24 NC</b>	4	H3	2-3/8"	7/8"	25	\$2.77
C62NF0010	C63NF0010	C64NF0010	<b>10-32 NF</b>	4	H3	2-3/8"	7/8"	21	\$2.77
C62NC0012	C63NC0012	C64NC0012	<b>12-24 NC</b>	4	H3	2-3/8"	15/16"	16	\$3.79
C62NF0012	C63NF0012	C64NF0012	<b>12-28 NF</b>	4	H3	2-3/8"	15/16"	14	\$3.79

**Carbon Steel Hand Taps - FRACTIONAL**

PART #			Machine Screw Thread	No. Of Flutes	Ground Thread Limit	OAL	Use Thread Length	Drill Size	List
TAPER	PLUG	BOTTOM							
C65NC0310	C66NC0310	C67NC0310	<b>1/4"-20 NC</b>	4	H3	2-1/2"	1"	7	\$2.50
C65NF0312	C66NF0312	C67NF0312	<b>1/4"-28 NF</b>	4	H3	2-1/2"	1"	3	\$2.50
C65NC0315	C66NC0315	C67NC0315	<b>5/16"-18 NC</b>	4	H3	2-23/32"	1-1/8"	F	\$3.47
C65NF0316	C66NF0316	C67NF0316	<b>5/16"-24 NF</b>	4	H3	2-23/32"	1-1/8"	I	\$3.47
C65NC0318	C66NC0318	C67NC0318	<b>3/8"-16 NC</b>	4	H3	2-15/16"	1-1/4"	5/16"	\$3.97
C65NF0319	C66NF0319	C67NF0319	<b>3/8"-24 NF</b>	4	H3	2-15/16"	1-1/4"	Q	\$3.97
C65NC0320	C66NC0320	C67NC0320	<b>7/16"-14 NC</b>	4	H3	3-5/32"	1-7/16"	U	\$4.77
C65NF0321	C66NF0321	C67NF0321	<b>7/16"-20 NF</b>	4	H3	3-5/32"	1-7/16"	25/64"	\$4.77
C65NC0322	C66NC0322	C67NC0322	<b>1/2"-13 NC</b>	4	H3	3-3/8"	1-21/32"	27/64"	\$6.37
C65NF0323	C66NF0323	C67NF0323	<b>1/2"-20 NF</b>	4	H3	3-3/8"	1-21/32"	29/64"	\$6.37
C65NC0325	C66NC0325	C67NC0325	<b>9/16"-12 NC</b>	4	H3	3-19/32"	1-21/32"	31/64"	\$8.28
C65NF0326	C66NF0326	C67NF0326	<b>9/16"-18 NF</b>	4	H3	3-19/32"	1-21/32"	33/64"	\$8.28
C65NC0327	C66NC0327	C67NC0327	<b>5/8"-11 NC</b>	4	H3	3-13/16"	1-13/16"	17/32"	\$10.16
C65NF0328	C66NF0328	C67NF0328	<b>5/8"-18 NF</b>	4	H3	3-13/16"	1-13/16"	37/64"	\$10.16
C65NC0331	C66NC0331	C67NC0331	<b>3/4"-10 NC</b>	4	H3	4-1/4"	2"	21/32"	\$11.75
C65NF0332	C66NF0332	C67NF0332	<b>3/4"-16 NF</b>	4	H3	4-1/4"	2"	11/16"	\$11.75
C65NC0333	C66NC0333	C67NC0333	<b>7/8"-9 NC</b>	4	H4	4-11/16"	2-7/32"	49/64"	\$17.93
C65NF0334	C66NF0334	C67NF0334	<b>7/8"-14 NF</b>	4	H4	4-11/16"	2-7/32"	13/16"	\$17.93
C65NC0335	C66NC0335	C67NC0335	<b>1"-8 NC</b>	4	H4	5-1/8"	2-1/2"	7/8"	\$22.64
C65NF0336	C66NF0336	C67NF0336	<b>1"-12 NF</b>	4	H4	5-1/8"	2-1/2"	59/64"	\$22.64
C65NS0337	C66NS0337	C67NS0337	<b>1"-14 NS</b>	4	H4	5-1/8"	2-1/2"	15/16"	\$22.64
C65NC0338	C66NC0338	C67NC0338	<b>1-1/8"- 7 NC</b>	4	H4	5-7/16"	2-9/16"	63/64"	\$40.15



5 PCS. PER  
PACK FROM  
4-40 TO  
1/2"-20.  
SOLD  
1 PC.  
OVER 1/2"-20.

**(HSS) High Speed Steel Hand Taps - MACHINE SCREW GROUND THREAD**

PART #			Machine Screw Thread	No. Of Flutes	Ground Thread Limit	OAL	Use Thread Length	Drill Size	List
TAPER	PLUG	BOTTOM							
262NC0004	263NC0004	264NC0004	4-40 NC	3	H2	1-7/8"	9/16"	43	\$5.50
262NF0004	263NF0004	264NF0004	4-48 NF	3	H2	1-7/8"	9/16"	42	\$5.50
262NC0005	263NC0005	264NC0005	5-40 NC	3	H2	1-15/16"	7/8"	38	\$5.50
262NF0005	263NF0005	264NF0005	5-44 NF	3	H2	1-15/16"	7/8"	37	\$5.50
262NC0006	263NC0006	264NC0006	6-32 NC	3	H2	2"	11/16"	35	\$5.50
262NF0006	263NF0006	264NF0006	6-40 NF	3	H2	2"	11/16"	33	\$5.50
262NC0008	263NC0008	264NC0008	8-32 NC	4	H3	2-1/8"	3/4"	29	\$4.66
262NF0008	263NF0008	264NF0008	8-36 NF	4	H3	2-1/8"	3/4"	29	\$4.66
262NC0010	263NC0010	264NC0010	10-24 NC	4	H3	2-3/8"	7/8"	25	\$5.10
262NF0010	263NF0010	264NF0010	10-32 NF	4	H3	2-3/8"	7/8"	21	\$5.10
262NC0012	263NC0012	264NC0012	12-24 NC	4	H3	2-3/8"	15/16"	16	\$5.42
262NF0012	263NF0012	264NF0012	12-28 NF	4	H3	2-3/8"	15/16"	14	\$5.42



**(HSS) High Speed Steel Hand Taps - FRACTIONAL GROUND THREAD**

PART #			Machine Screw Thread	No. Of Flutes	Ground Thread Limit	OAL	Use Thread Length	Drill Size	List
TAPER	PLUG	BOTTOM							
265NC0310	266NC0310	267NC0310	1/4"-20 NC	4	H3	2-1/2"	1"	7	\$5.68
265NF0312	266NF0312	267NF0312	1/4"-28 NF	4	H3	2-1/2"	1"	3	\$5.68
265NC0315	266NC0315	267NC0315	5/16"-18 NC	4	H3	2-23/32"	1-1/8"	F	\$6.70
265NF0316	266NF0316	267NF0316	5/16"-24 NF	4	H3	2-23/32"	1-1/8"	I	\$6.70
265NC0318	266NC0318	267NC0318	3/8"-16 NC	4	H3	2-15/16"	1-1/4"	5/16"	\$7.85
265NF0319	266NF0319	267NF0319	3/8"-24 NF	4	H3	2-15/16"	1-1/4"	Q	\$7.85
265NC0320	266NC0320	267NC0320	7/16"-14 NC	4	H3	3-5/32"	1-7/16"	U	\$12.15
265NF0321	266NF0321	267NF0321	7/16"-20 NF	4	H3	3-5/32"	1-7/16"	25/64"	\$12.15
265NC0322	266NC0322	267NC0322	1/2"-13 NC	4	H3	3-3/8"	1-21/32"	27/64"	\$14.43
265NF0323	266NF0323	267NF0323	1/2"-20 NF	4	H3	3-3/8"	1-21/32"	29/64"	\$14.43
265NC0325	266NC0325	267NC0325	9/16"-12 NC	4	H3	3-19/32"	1-21/32"	31/64"	\$17.05
265NF0326	266NF0326	267NF0326	9/16"-18 NF	4	H3	3-19/32"	1-21/32"	33/64"	\$17.05
265NC0327	266NC0327	267NC0327	5/8"-11 NC	4	H3	3-13/16"	1-13/16"	17/32"	\$20.12
265NF0328	266NF0328	267NF0328	5/8"-18 NF	4	H3	3-13/16"	1-13/16"	37/64"	\$20.12
265NS0329	266NS0329	267NS0329	11/16"-11 NS	4	H3	4-1/32"	1-13/16"	19/32"	\$21.70
265NS0330	266NS0330	267NS0330	11/16"-16 NS	4	H3	4-1/32"	1-13/16"	5/8"	\$21.70
265NC0331	266NC0331	267NC0331	3/4"-10 NC	4	H3	4-1/4"	2"	21/32"	\$32.10
265NF0332	266NF0332	267NF0332	3/4"-16 NF	4	H3	4-1/4"	2"	11/16"	\$32.10
265NC0333	266NC0333	267NC0333	7/8"-9 NC	4	H4	4-11/16"	2-7/32"	49/64"	\$44.78
265NF0334	266NF0334	267NF0334	7/8"-14 NF	4	H4	4-11/16"	2-7/32"	13/16"	\$44.78
265NC0335	266NC0335	267NC0335	1"-8 NC	4	H4	5-1/8"	2-1/2"	7/8"	\$60.28
265NF0336	266NF0336	267NF0336	1"-12 NF	4	H4	5-1/8"	2-1/2"	59/64"	\$60.28
265NS0337	266NS0337	267NS0337	1"-14 NS	4	H4	5-1/8"	2-1/2"	15/16"	\$60.28



5 PCS. PER  
PACK FROM  
4-40 TO  
1/2"-20.  
SOLD  
1 PC.  
OVER 1/2"-20.



- ◆ National Pipe Tap
- ◆ High Speed Steel
- ◆ Ground Thread
- ◆ Heavy Duty



**SOLD INDIVIDUALLY  
IN PLASTIC TUBES**

### (HSS) NPT Taper Pipe Taps

Part #	Size	Threads Per Inch NPT Only	No. Of Flutes	OAL	Thread Length	List
265TP0464	1/16"	27	4	2-1/8"	11/16"	\$13.13
265TP0864	1/8"	27	4	2-1/8"	3/4"	\$13.13
265TP1664	1/4"	18	4	2-7/16"	1-1/16"	\$18.85
265TP2464	3/8"	18	4	2-9/16"	1-1/16"	\$23.81
265TP3264	1/2"	14	4	3-1/8"	1-3/8"	\$42.66
265TP4864	3/4"	14	5	3-1/4"	1-3/8"	\$63.49
265TP6464	1"	11.5	5	3-3/4"	1-3/4"	\$104.17
265TP8064	1-1/4"	11.5	5	4"	1-3/4"	\$151.42
265TP9664	1-1/2"	11.5	7	4-1/4"	1-3/4"	\$219.30
265TP9964	2"	11.5	7	4-1/2"	1-3/4"	\$308.63

- ◆ National Pipe Tap
- ◆ Carbon Steel
- ◆ Ground Thread
- ◆ General Purpose



**SOLD INDIVIDUALLY  
IN PLASTIC TUBES**

### (Carbon Steel) NPT Taper Pipe Taps

Part #	Size	Threads Per Inch NPT Only	No. Of Flutes	OAL	Thread Length	List
NPT0464	1/16"	27	4	2-1/8"	11/16"	\$6.25
NPT0864	1/8"	27	4	2-1/8"	3/4"	\$6.25
NPT1664	1/4"	18	4	2-7/16"	1-1/16"	\$7.42
NPT2464	3/8"	18	4	2-9/16"	1-1/16"	\$9.90
NPT3264	1/2"	14	4	3-1/8"	1-3/8"	\$17.31
NPT4864	3/4"	14	5	3-1/4"	1-3/8"	\$24.18
NPT6464	1"	11.5	5	3-3/4"	1-3/4"	\$41.75
NPT8864	1-1/4"	11.5	5	4"	1-3/4"	\$57.98
NPT9664	1-1/2"	11.5	7	4-1/4"	1-3/4"	\$85.03
NPT9964	2"	11.5	7	4-1/2"	1-3/4"	\$119.06

### T-Handle Tap Wrench

Part #	O.D. Size	List
271TT0001	#0 - 1/4"	\$11.76
271TT0002	#10 - 1/2"	\$16.41



### Tap Reamer Wrench

Part #	O.D. Size	Size	List
270TW0000	#0-1/4"	TW0	\$12.43
270TW0004	#0-3/8"	TW4	\$17.32
270TW0005	#7-1/2"	TW5	\$21.09
270TW0006	#7-3/4"	TW6	\$29.75
270TW0007	1/4" → 1-1/8"	TW7	\$57.64



### NPT TAP-DRILL CHART



DRILL THIS SIZE HOLE			TO TAP FOR THIS BOLT OR SCREW
DECIMAL INCHES	DRILL SIZE	NEAREST FRACTION	
.3390"	Ltr. R	none	1/8-27 NPT
.4375"	7/16"	7/16"	1/4-18 NPT
.5781"	37/64"	37/64"	3/8- 18 NPT
.7031"	45/64"	45/64"	1/2-14 NPT
.9219"	59/64"	59/64"	3/4-14 NPT
1.1562"	1-5/32"	1-5/32"	1 - 11-1/2 NPT
1.5000"	1-1/2"	1-1/2"	1-1/4 - 11-1/2 NPT
1.7344"	1-47/64"	1-47/64"	1-1/2 - 11-1/2 NPT
2.2188"	2-3/16"	2-3/16"	2 - 11-1/2 NPT



Wrenches will accommodate all HSS & Carbon Hand Taps within O.D. size.  
O.D. Size = Actual Tap Size (machine screw thread).

## Combo Drill Taps - HSS

Part #	Thread Size	Drill Size	Thread Length	OAL	List
266TD0632	<b>6-32</b>	0.1095	11/16"	2"	\$18.33
266TD0832	<b>8-32</b>	0.1360	3/4"	2-1/8"	\$18.80
266TD0836	<b>8-36</b>	0.1360	3/4"	2-1/8"	\$18.80
266TD1024	<b>10-24</b>	0.1520	7/8"	2-3/8"	\$19.43
266TD1032	<b>10-32</b>	0.1520	7/8"	2-3/8"	\$19.43
266TD1224	<b>12-24</b>	0.1770	15/16"	2-3/8"	\$20.42
267TD1420	<b>1/4"-20</b>	0.2010	15/16"	2-1/2"	\$22.70
267TD1428	<b>1/4"-28</b>	0.2010	15/16"	2-1/2"	\$22.70
267TD5618	<b>5/16"-18</b>	0.2570	1-1/8"	3"	\$27.26
267TD3816	<b>3/8"-16</b>	0.3125	1-1/4"	3-1/2"	\$31.73
267TD3824	<b>3/8"-24</b>	0.3125	1-1/4"	3-1/2"	\$31.73
267TD7614	<b>7/16"-14</b>	0.3680	1-7/16"	3-7/8"	\$37.68
267TD1213	<b>1/2"-13</b>	0.4250	1-21/32"	4-1/4"	\$44.54



- ◆ High Speed Steel
- ◆ Ground Thread
- ◆ Heavy Duty

Drill and Tap holes in one operation, saving a complete set-up!

**SOLD INDIVIDUALLY  
IN PLASTIC TUBES**

## Spiral Point (Gun) Taps - HSS

Part #	Size	No. Of Flutes	OAL	Thread Length	Drill Size	List
265SP0632	<b>6-32</b>	2	2"	11/16"	35	\$5.77
265SP0832	<b>8-32</b>	2	2-1/8"	3/4"	29	\$5.77
265SP1024	<b>10-24</b>	2	2-3/8"	7/8"	25	\$5.77
265SP1032	<b>10-32</b>	2	2-3/8"	7/8"	25	\$5.77
265SP1224	<b>12-24</b>	2	2-3/8"	15/16"	16	\$6.02
265SP1420	<b>1/4"-20</b>	2	2-1/2"	1"	7	\$6.02
265SP1428	<b>1/4"-28</b>	2	2-1/2"	1"	7	\$6.02
265SP5618	<b>5/16"-18</b>	2	2-23/32"	1-1/8"	F	\$6.78
265SP3816	<b>3/8"-16</b>	3	2-15/16"	1-1/4"	5/16"	\$7.74
265SP1312	<b>1/2"-13</b>	3	3-3/8"	1-21/32"	27/64"	\$14.31



- ◆ High Speed Steel
- ◆ Ground Thread
- ◆ Heavy Duty

Spiral Point Taps are ideal for machine tapping through holes or blind holes with adequate bottom clearance.



**Sold  
5/Pack**

## Spiral Point (Gun) Taps - HSS Made in USA

Part #	Size	No. Of Flutes	OAL	Thread Length	Drill Size	List
GUN-0632	<b>6-32</b>	2	2"	11/16"	35	\$8.32
GUN-0832	<b>8-32</b>	2	2-1/8"	3/4"	29	\$8.55
GUN-1024	<b>10-24</b>	2	2-3/8"	7/8"	25	\$8.94
GUN-1032	<b>10-32</b>	2	2-3/8"	7/8"	25	\$8.94
GUN-1224	<b>12-24</b>	2	2-3/8"	15/16"	16	\$10.91
GUN-1420	<b>1/4"-20</b>	2	2-1/2"	1"	7	\$9.34
GUN-1428	<b>1/4"-28</b>	2	2-1/2"	1"	7	\$9.34
GUN-5618	<b>5/16"-18</b>	2	2-23/32"	1-1/8"	F	\$11.37
GUN-3816	<b>3/8"-16</b>	3	2-15/16"	1-1/4"	5/16"	\$12.47
GUN-1312	<b>1/2"-13</b>	3	3-3/8"	1-21/32"	27/64"	\$25.69
GUN-3410	<b>3/4"-10</b>	3	3-3/8"	1-21/32"	27/64"	\$69.95



- ◆ High Speed Steel
- ◆ Ground Thread
- ◆ Heavy Duty



**Made In**



**Sold  
5/Pack**



- ◆ Individually Blister Packaged
- ◆ Industrial Quality

- Stainless Steel
- Ferrous Metals
- Non-Ferrous Metals

◆ 5/8" - 11 SPINDLE



## Industrial Wire Cups

Part #	Size	Description	Wire Type	List
KCC075	2-3/4"	Knotted Cup	.020 Carbon Steel	\$13.75
KCS075	2-3/4"	Knotted Cup	.020 Stainless Steel	\$19.80
KCC100	4"	Knotted Cup	.020 Carbon Steel	\$19.86
KCC150	6"	Knotted Cup	.020 Carbon Steel	\$40.94
CCC075	3"	Crimped Cup	.014 Carbon Steel	\$12.99
CCC100	4"	Crimped Cup	.014 Carbon Steel	\$18.94

USE RED - NUT WIRE CUP ADAPTER IN CLOCKWISE ROTATION ONLY.



## The Red-Nut Wire Cup Adapter

Part #	Description	List
REDNUT	5/8"-11 Bolt and Nut Adapter	\$35.00

- ◆ 3-Flat Shank
- ◆ For Use in 1/2" Handheld Drills
- ◆ Light Grinding





**Stringer Bead Wheel**

**NEW  
PACKAGING**



- ◆ Individually Blister Packaged
- ◆ Industrial Quality
- ➔ Stainless Steel
- ➔ Ferrous Metals
- ➔ Non-Ferrous Metals
- ◆ 5/8" - 11 SPINDLE

## Industrial Wire Wheels

Part #	Size	Description	Wire Type	List
TKW100	4"	Twist Knot Wheel	.020 Carbon Steel	\$15.89
SBW100	4"	Stringer Bead Wheel	.020 Carbon Steel	\$16.19
SBS100	4"	Stringer Bead Wheel	.020 <b>Stainless Steel</b>	\$34.83
SBW175	7"	Stringer Bead Wheel	.020 Carbon Steel	\$46.98
WBB120	12"	Walk Behind Wire Brush	.020 Carbon Steel (1" Spindle)	\$108.08

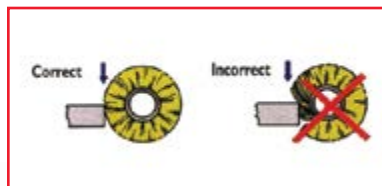

## Hand Wire Brush

Part #	Description	Material	List
VIP100	Hand Wire Brush	Carbon Steel	\$6.95

APPLICATION	KNOTTED CUP WIRE BRUSH	CRIMPED CUP WIRE BRUSH	TWIST KNOT WIRE BRUSH	STRINGER BEAD WIRE BRUSH
DEBURRING (FINE)	⊗	⊗		
DEBURRING (COURSE)			⊗	⊗
EDGE BLENDING	⊗	⊗		
WELD, SCALE REMOVAL			⊗	⊗
WELD PREP				⊗
SURFACE FINISHING	⊗	⊗		
RUST OXIDE (FINE)	⊗	⊗		
RUST OXIDE (COARSE)			⊗	⊗
PAINT REMOVAL	⊗	⊗		
ROUGHENING	⊗	⊗	⊗	⊗
CLEANING	⊗	⊗		⊗
FLASH REMOVAL		⊗	⊗	
TOOL MARK REMOVAL		⊗	⊗	
EXPANSION JOINT		⊗	⊗	







**Cylinder**

Part #	Dia.	Cut	Qty.	List
CBA-1	1/4"	5/8"	1	\$17.12
CBA-3	3/8"	3/4"	1	\$24.07
CBA-5	1/2"	1"	1	\$37.76
CBA-7	3/4"	1"	1	\$81.55



**Tree w/ Radius**

Part #	Dia.	Cut	Qty.	List
CBF-1	1/4"	5/8"	1	\$25.98
CBF-3	3/8"	3/4"	1	\$32.78
CBF-5	1/2"	1"	1	\$47.20
CBF-6	5/8"	1"	1	\$67.09



**14° Taper w/ Radius**

Part #	Dia.	Cut	Qty.	List
CBL-1	1/4"	5/8"	1	\$26.65
CBL-3	3/8"	1-1/16"	1	\$40.25
CBL-4	1/2"	1-1/8"	1	\$51.35
CBL-5	5/8"	1-3/16"	1	\$90.16
CBL-7	3/4"	1-1/2"	1	\$129.42



**Cylinder w/ End Cut**

Part #	Dia.	Cut	Qty.	List
CBB-1	1/4"	5/8"	1	\$23.18
CBB-3	3/8"	3/4"	1	\$33.27
CBB-5	1/2"	1"	1	\$51.75
CBB-7	3/4"	1"	1	\$92.53



**Tree w/ Point**

Part #	Dia.	Cut	Qty.	List
CBG-1	1/4"	5/8"	1	\$25.96
CBG-3	3/8"	3/4"	1	\$33.32
CBG-5	1/2"	1"	1	\$47.20



**Pointed Cone**

Part #	Dia.	Cut	Qty.	List
CBM-2	1/4"	3/4"	1	\$27.76
CBM-4	3/8"	5/8"	1	\$39.72
CBM-5	1/2"	7/8"	1	\$50.84



**Cylinder w/ Radius**

Part #	Dia.	Cut	Qty.	List
CBC-1	1/4"	5/8"	1	\$24.46
CBC-3	3/8"	3/4"	1	\$32.38
CBC-5	1/2"	1"	1	\$50.84
CBC-6	5/8"	1"	1	\$56.73



**Flame**

Part #	Dia.	Cut	Qty.	List
CBH-1	1/4"	1/2"	1	\$29.21
CBH-5	1/2"	1-1/4"	1	\$65.06



**Inverted Cone**

Part #	Dia.	Cut	Qty.	List
CBN-1	1/4"	5/16"	1	\$23.76
CBN-2	3/8"	3/8"	1	\$44.21
CBN-4	1/2"	1/2"	1	\$45.28

**Made In**



- ◆ Solid Carbide
- ◆ Bright Finish
- Ferrous Metals
- Cast Iron
- Steel 40-55 Rc
- Steel 55-60 Rc
- Nickel
- Stainless Steel
- Weldments

**Better For:**

- Brass
- Bronze
- Copper



**Ball**

Part #	Dia.	Cut	Qty.	List
CBD-1	1/4"	1/4"	1	\$22.21
CBD-3	3/8"	3/8"	1	\$25.97
CBD-5	1/2"	1/2"	1	\$35.17



**Cone 60°**

Part #	Dia.	Cut	Qty.	List
CBJ-1	1/4"	3/16"	1	\$24.07
CBJ-3	3/8"	1/4"	1	\$29.61
CBJ-5	1/2"	7/16"	1	\$36.54



**Oval**

Part #	Dia.	Cut	Qty.	List
CBE-1	1/4"	3/8"	1	\$26.83
CBE-3	3/8"	5/8"	1	\$29.27
CBE-5	1/2"	7/8"	1	\$51.75
CBE-6	5/8"	1"	1	\$67.47



**Cone 90°**

Part #	Dia.	Cut	Qty.	List
CBK-1	1/4"	1/4"	1	\$24.64
CBK-3	3/8"	3/8"	1	\$30.36
CBK-5	1/2"	1/2"	1	\$36.54



### Cylinder

Part #	Dia.	Cut	Qty.	List
SA-1NF	1/4"	3/4"	1	\$19.25
SA-3NF	3/8"	3/4"	1	\$27.96
SA-5NF	1/2"	1"	1	\$42.17
SA-6NF	5/8"	1"	1	\$50.10
SA-7NF	3/4"	1"	1	\$69.58



### Ball

Part #	Dia.	Cut	Qty.	List
SD-1NF	1/4"	1/4"	1	\$18.47
SD-3NF	3/8"	3/8"	1	\$25.30
SD-5NF	1/2"	1/2"	1	\$35.84
SD-6NF	5/8"	5/8"	1	\$45.33
SD-7NF	3/4"	3/4"	1	\$60.64



### Tree w/ Radius

Part #	Dia.	Cut	Qty.	List
SF-1NF	1/4"	3/4"	1	\$19.25
SF-3NF	3/8"	3/4"	1	\$28.23
SF-5NF	1/2"	1"	1	\$41.94
SF-6NF	5/8"	1"	1	\$50.60
SF-14NF	3/4"	1-1/4"	1	\$94.10



### Cylinder w/ Radius

Part #	Dia.	Cut	Qty.	List
SC-1NF	1/4"	3/4"	1	\$19.53
SC-3NF	3/8"	3/4"	1	\$28.23
SC-5NF	1/2"	1"	1	\$42.17
SC-6NF	5/8"	1"	1	\$50.88
SC-7NF	3/4"	1"	1	\$70.63



### Oval

Part #	Dia.	Cut	Qty.	List
SE-3NF	3/8"	5/8"	1	\$28.46
SE-5NF	1/2"	7/8"	1	\$42.17
SE-6NF	5/8"	1"	1	\$52.20
SE-7NF	3/4"	1"	1	\$70.90



### 14° Taper w/ Radius

Part #	Dia.	Cut	Qty.	List
SL-3NF	3/8"	1-1/16"	1	\$34.01
SL-4NF	1/2"	1-1/8"	1	\$43.77
SL-6NF	5/8"	1-5/16"	1	\$78.83
SL-7NF	3/4"	1-1/2"	1	\$108.08



### Made In



- ◆ Solid Carbide
- ◆ Deep Flute
- ◆ Bright Finish

- Non-Ferrous (Soft) Metals
- Aluminum
  - Zinc
  - Plastics

# SOLID CARBIDE BURS



1/8"  
5/32"  
3/16"  
7/32"  
1/4"  
9/32"  
5/16"  
11/32"  
3/8"  
13/32"  
7/16"  
15/32"  
1/2"

**274MC0001**  
13 Steps 1/8" - 1/2"  
List \$44.00

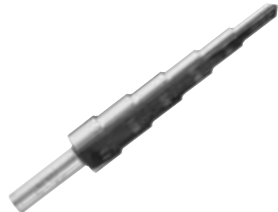

3/16"  
1/4"  
5/16"  
3/8"  
7/16"  
1/2"

**274MC0002**  
6 Steps 3/16" - 1/2"  
List \$42.85



1/4"  
5/16"  
3/8"  
7/16"  
1/2"  
9/16"  
5/8"  
11/16"  
3/4"

**274MC0003**  
9 Steps 1/4" - 3/4"  
List \$53.27



3/16"  
1/4"  
5/16"  
3/8"  
7/16"  
1/2"  
9/16"  
5/8"  
11/16"  
3/4"  
13/16"  
7/8"

**274MC0004**  
12 Steps 3/16" - 7/8"  
List \$59.58



7/16"  
1/2"  
9/16"  
5/8"  
11/16"  
3/4"  
13/16"  
7/8"  
15/16"  
1"  
1-1/16"  
1-1/8"

**274MC0005**  
12 Steps 7/16" - 1-1/8"  
List \$84.83



3/4"  
13/16"  
7/8"  
15/16"  
1"  
1-1/16"  
1-1/8"  
1-3/16"  
1-1/4"  
1-5/16"  
1-3/8"

**274MC0006**  
11 Steps 3/4" - 1-3/8"  
List \$113.09

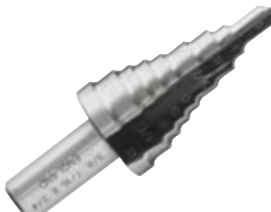

3/8"  
7/16"  
3/4"

For drilling 3 standard size holes to accommodate drive screws for knockout punches.

**274MC0007**  
3 Steps 3/8" - 3/4"  
List \$69.42



7/8"  
1-1/8"

7/8" hole for 1/2" conduit.  
1-1/8" hole for 3/4" conduit.

**274MC0008**  
2 Steps 7/8" - 1-1/8"  
List \$82.81



7/8"  
1-1/8"  
1-7/32"  
1-1/4"  
1-3/8"

1-7/32" hole for oil tight switches.

**274MC0009**  
5 Steps 7/8" - 1-3/8"  
List \$99.50



7/8"

**274MC0010**  
1 Cone 7/8"  
List \$59.58



1/4"  
3/8"  
1/2"  
5/8"  
3/4"  
7/8"  
1"  
1-1/8"  
1-1/4"  
1-3/8"

3/16" Drilling Depth

**274MC0011**  
10 Steps 1/4" - 1-3/8"  
List \$106.33

**THE BIG 10**  
One Size Fits All

- ◆ M2 HSS
  - ◆ Lobbed Non-Slip Shank
  - ◆ Drill 1/8" Thick
  - ◆ Double Flute
  - ◆ Bright Finish
- Ferrous & Non-Ferrous Sheet Metals
  - Plastic Laminates
  - Sink Grade Stainless Steel
  - Auto Body Repair
  - Electrical
  - HVAC
- STEP DRILLS ARE SOLD INDIVIDUALLY.

More accurate control of hole size in various sheet materials up to 1/8" thick. Each step bit drills a range of sizes. The further the bit advances, the larger the diameter of the hole gets. Because step drill bits enter the material one step at a time, the operator can drill the desired hole by counting the individual steps, or by using a washer as a simple stop. The self starting tip eliminates the need for pilot holes. Applications include junction boxes, switch boxes, metal studs, electrical applications, lighting fixtures, auto body work, and many other uses.



**274HEX01**  
**13 Steps 1/8" - 1/2"**  
 List \$45.32

1/8"  
 5/32"  
 3/16"  
 7/32"  
 1/4"  
 9/32"  
 5/16"  
 11/32"  
 3/8"  
 13/32"  
 7/16"  
 15/32"  
 1/2"



**274HEX02**  
**6 Steps 3/16" - 1/2"**  
 List \$44.13

3/16"  
 1/4"  
 5/16"  
 3/8"  
 7/16"  
 1/2"



**274HEX03**  
**9 Steps 1/4" - 3/4"**  
 List \$54.87

1/4"  
 5/16"  
 3/8"  
 7/16"  
 1/2"  
 9/16"  
 5/8"  
 11/16"  
 3/4"



**274HEX04**  
**12 Steps 3/16" - 7/8"**  
 List \$70.57

3/16"  
 1/4"  
 5/16"  
 3/8"  
 7/16"  
 1/2"  
 9/16"  
 5/8"  
 11/16"  
 3/4"  
 13/16"  
 7/8"



**274HEX05**  
**12 Steps 7/16" - 1-1/8"**  
 List \$100.48

7/16"  
 1/2"  
 9/16"  
 5/8"  
 11/16"  
 3/4"  
 13/16"  
 7/8"  
 15/16"  
 1"  
 1-1/16"  
 1-1/8"



**274HEX08**  
**2 Steps 7/8" - 1-1/8"**  
 List \$98.09

7/8"  
 1-1/8"  
 7/8" hole for 1/2" conduit.  
 1-1/8" hole for 3/4" conduit.



**IMPACT**  
 1/4" HEX IMPACT SHANK

# M2 HSS FAST SPIRAL STEP DRILL

- ◆ M2 HSS
- ◆ Fast Spiral Flutes
- ◆ Jam Free Performance
- ◆ Self Starting Split Point
- ◆ Bright Finish
- Ferrous & Non-Ferrous Sheet Metals
- Plastic Laminates
- Sink Grade Stainless Steel
- Auto Body Repair
- Electrical
- HVAC





3-FLAT SHANK

Reamer - CAR / Construction - Spiral Flute - HSS

- ◆ High Speed Steel (HSS)
- ◆ Tapered Point
- ◆ Left-Hand Spiral
- ◆ Right-Hand Cut
- ◆ 3-Flat Shank

Made in Europe

Part #	Size	Point Diameter	OAL	Flute	Shank	Type	List
CRF-2464	3/8"	0.250	5"	4"	3/8"	3-Flat Car / Constr.	\$46.05
CRF-2864	7/16"	0.281	5-1/4"	4"	7/16"	3-Flat Car / Constr.	\$52.07
CRF-3264	1/2"	0.343	6"	4-1/2"	1/2"	3-Flat Car / Constr.	\$59.10
CRF-3664	9/16"	0.343	6-1/4"	4-1/2"	1/2"	3-Flat Car / Constr.	\$62.56
CRF-4064	5/8"	0.343	6-1/2"	4-1/2"	1/2"	3-Flat Car / Constr.	\$69.03
CRF-4464	11/16"	0.375	7"	4-1/2"	1/2"	3-Flat Car / Constr.	\$79.86
CRF-4864	3/4"	0.406	7-1/4"	5"	1/2"	3-Flat Car / Constr.	\$92.10
CRF-5264	13/16"	0.468	7-1/4"	5"	1/2"	3-Flat Car / Constr.	\$97.66
CRF-5664	7/8"	0.500	7-1/4"	5"	1/2"	3-Flat Car / Constr.	\$109.48
CRF-6064	15/16"	0.585	7-1/4"	5"	1/2"	3-Flat Car / Constr.	\$122.30
CRF-6464	1"	0.594	7-1/4"	5"	1/2"	3-Flat Car / Constr.	\$129.64
CRF-6864	1-1/16"	0.807	7-1/4"	5"	1/2"	3-Flat Car / Constr.	\$150.10

Reaming Steel For Aligning Existing Holes & Bolt / Rivet Installation



3-FLAT SHANK

Reamer - CAR / Construction - *Fast Spiral* - HSS

- ◆ High Speed Steel (HSS)
- ◆ Tapered Point
- ◆ Left-Hand Spiral
- ◆ Right-Hand Cut
- ◆ 3-Flat Shank

Made in Europe

Part #	Size	Point Diameter	OAL	Flute	Shank	Type	List
CFF-2464	3/8"	0.250	5"	4"	3/8"	3-Flat Car / Constr.	\$77.07
CFF-3264	1/2"	0.343	6"	4-1/2"	1/2"	3-Flat Car / Constr.	\$91.75
CFF-3664	9/16"	0.343	6-1/4"	4-1/2"	1/2"	3-Flat Car / Constr.	\$97.43
CFF-4064	5/8"	0.343	6-1/2"	4-1/2"	1/2"	3-Flat Car / Constr.	\$106.76
CFF-4464	11/16"	0.375	7"	4-1/2"	1/2"	3-Flat Car / Constr.	\$118.78
CFF-4864	3/4"	0.406	7-1/4"	5"	1/2"	3-Flat Car / Constr.	\$141.86
CFF-5264	13/16"	0.468	7-1/4"	5"	1/2"	3-Flat Car / Constr.	\$145.45
CFF-5664	7/8"	0.500	7-1/4"	5"	1/2"	3-Flat Car / Constr.	\$160.81
CFF-6064	15/16"	0.585	7-1/4"	5"	1/2"	3-Flat Car / Constr.	\$160.81
CFF-6464	1"	0.594	7-1/4"	5"	1/2"	3-Flat Car / Constr.	\$188.17
CFF-8064	1-1/4"	0.719	7-1/4"	5"	1/2"	3-Flat Car / Constr.	\$293.59



**Reamer - CAR / Construction - Spiral Flute - HEX - HSS**

Part #	Size	Point Diameter	OAL	Flute	Shank	Type	List
CHX-4464	11/16"	0.375	6-3/8"	4-1/2"	1-1/16"	HEX Car	\$78.66
CHX-5264	13/16"	0.468	7"	5"	1-1/4"	HEX Car	\$93.22
CHX-6064	15/16"	0.585	7"	5"	1-7/16"	HEX Car	\$110.81
CHX-6864	1-1/16"	0.807	7"	5"	1-5/8"	HEX Car	\$143.87

- ◆ High Speed Steel (HSS)
- ◆ Tapered Point
- ◆ Left-Hand Spiral
- ◆ Right-Hand Cut
- ◆ HEX Nut Shank

Made in Europe

Reaming Steel For Aligning Existing Holes & Bolt / Rivet Installation



**Reamer - BRIDGE - Spiral Flute - HEX - HSS**

Part #	Size	Point Diameter	OAL	Flute	Shank	Type	List
CBB-4464	11/16"	0.375	9-1/4"	7-1/8"	1-1/16"	HEX Bridge	\$104.38
CBB-5264	13/16"	0.468	9-3/8"	7-3/8"	1-1/4"	HEX Bridge	\$131.88
CBB-6064	15/16"	0.585	9-3/8"	7-3/8"	1-7/16"	HEX Bridge	\$156.75
CBB-6864	1-1/16"	0.807	9-3/8"	7-3/8"	1-5/8"	HEX Bridge	\$213.34

- ◆ High Speed Steel (HSS)
- ◆ Tapered Point
- ◆ Left-Hand Spiral
- ◆ Right-Hand Cut
- ◆ HEX Nut Shank

Made in Europe



Bridge Construction



Ship Building



Structural Steel Erection

Reaming Steel For Aligning Existing Holes & Bolt / Rivet Installation



Made In



Black & Gold

- ◆ High Speed Steel (HSS)
- ◆ Tapered Point
- ◆ Left-Hand Spiral
- ◆ Right-Hand Cut
- ◆ 3-Flat Shank
- Structural Plate



3-FLAT SHANK

Reamer - CAR / Construction - Spiral Flute - HSS

Part #	Size	Point Diameter	OAL	Flute	Shank	Type	List
ASF-2464	3/8"	0.250	5"	4"	3/8"	3-Flat Car / Constr.	\$80.74
ASF-3264	1/2"	0.281	6"	4-1/2"	1/2"	3-Flat Car / Constr.	\$96.16
ASF-3664	9/16"	0.343	6-1/4"	4-1/2"	1/2"	3-Flat Car / Constr.	\$102.34
ASF-4064	5/8"	0.343	6-1/2"	4-1/2"	1/2"	3-Flat Car / Constr.	\$111.69
ASF-4464	11/16"	0.375	7"	4-1/2"	1/2"	3-Flat Car / Constr.	\$124.15
ASF-4864	3/4"	0.406	7-1/4"	5"	1/2"	3-Flat Car / Constr.	\$148.96
ASF-5264	13/16"	0.468	7-1/4"	5"	1/2"	3-Flat Car / Constr.	\$152.64
ASF-5664	7/8"	0.500	7-1/4"	5"	1/2"	3-Flat Car / Constr.	\$168.24
ASF-6064	15/16"	0.585	7-1/4"	5"	1/2"	3-Flat Car / Constr.	\$168.24
ASF-6464	1"	0.594	7-1/4"	5"	1/2"	3-Flat Car / Constr.	\$197.38
ASF-8064	1-1/4"	0.719	7-1/4"	5"	1/2"	3-Flat Car / Constr.	\$308.39

Made In



Black & Gold

- ◆ High Speed Steel (HSS)
- ◆ Tapered Point
- ◆ Left-Hand Spiral
- ◆ Right-Hand Cut
- ◆ 3-Flat Shank
- Structural Plate



3-FLAT SHANK

Reamer - CAR / Construction - *Fast Spiral* - HSS

Part #	Size	Point Diameter	OAL	Flute	Shank	Type	List
AFC-2464	3/8"	0.250	5"	4"	3/8"	3-Flat Car / Constr.	\$89.05
AFC-3264	1/2"	0.281	6"	4-1/2"	1/2"	3-Flat Car / Constr.	\$106.02
AFC-3664	9/16"	0.343	6-1/4"	4-1/2"	1/2"	3-Flat Car / Constr.	\$112.59
AFC-4064	5/8"	0.343	6-1/2"	4-1/2"	1/2"	3-Flat Car / Constr.	\$123.36
AFC-4464	11/16"	0.375	7"	4-1/2"	1/2"	3-Flat Car / Constr.	\$137.26
AFC-4864	3/4"	0.406	7-1/4"	5"	1/2"	3-Flat Car / Constr.	\$163.91
AFC-5264	13/16"	0.468	7-1/4"	5"	1/2"	3-Flat Car / Constr.	\$168.06
AFC-5664	7/8"	0.500	7-1/4"	5"	1/2"	3-Flat Car / Constr.	\$185.79
AFC-6064	15/16"	0.585	7-1/4"	5"	1/2"	3-Flat Car / Constr.	\$185.79
AFC-6464	1"	0.594	7-1/4"	5"	1/2"	3-Flat Car / Constr.	\$217.43
AFC-8064	1-1/4"	0.719	7-1/4"	5"	1/2"	3-Flat Car / Constr.	\$339.23

Made In



Black & Gold

- ◆ High Speed Steel (HSS)
- ◆ Tapered Point
- ◆ Left-Hand Spiral
- ◆ Right-Hand Cut
- ◆ HEX Shank
- Structural Plate



Reamer - CAR - Spiral Flute - *HEX* - HSS

Part #	Size	Point Diameter	OAL	Flute	Shank	Type	List
ACX-4464	11/16"	0.375	6-3/8"	4-1/2"	1-1/16"	HEX Car	\$145.71
ACX-5264	13/16"	0.468	7"	5"	1-1/4"	HEX Car	\$174.63
ACX-6064	15/16"	0.585	7"	5"	1-7/16"	HEX Car	\$197.60
ACX-6864	1-1/16"	0.807	7"	5"	1-5/8"	HEX Car	\$258.74



**Made In**



**Black & Gold**

- ◆ High Speed Steel (HSS)
  - ◆ Tapered Point
  - ◆ Left-Hand Spiral
  - ◆ Right-Hand Cut
  - ◆ HEX Shank
- Structural Plate

**Reamer - BRIDGE - Spiral Flute - HEX - HSS**

Part #	Size	Point Diameter	OAL	Flute	Shank	Type	List
ABX-4464	11/16"	0.375	9-1/4"	7-1/8"	1-1/16" HEX	Bridge	\$177.99
ABX-5264	13/16"	0.468	9-3/8"	7-3/8"	1-1/4" HEX	Bridge	\$202.55
ABX-6064	15/16"	0.585	9-3/8"	7-3/8"	1-7/16" HEX	Bridge	\$230.17
ABX-6864	1-1/16"	0.807	9-3/8"	7-3/8"	1-5/8" HEX	Bridge	\$284.56

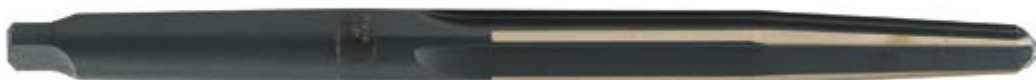

**Made In**



**Black & Gold**

- ◆ High Speed Steel (HSS)
  - ◆ Tapered Point
  - ◆ Left-Hand Spiral
  - ◆ Right-Hand Cut
  - ◆ Taper Shank
- Structural Steel Assemblies
- Bridge Erection
- Ship Construction

**Reamer - BRIDGE - Straight Flute - Morse Taper - HSS**

Part #	Size	Point Diameter	OAL	Flute	Shank	Type	List
ABT-4464	11/16"	0.375	11-3/4"	7-1/8"	#3 Taper	Bridge - Straight	\$148.56
ABT-5264	13/16"	0.468	12"	7-3/8"	#3 Taper	Bridge - Straight	\$170.44
ABT-6064	15/16"	0.585	12"	7-3/8"	#3 Taper	Bridge - Straight	\$193.81
ABT-6864	1-1/16"	0.807	12"	7-3/8"	#3 Taper	Bridge - Straight	\$239.53



**Reamer - BRIDGE - Spiral Flute - Morse Taper - HSS**

Part #	Size	Point Diameter	OAL	Flute	Shank	Type	List
AFF-4464	11/16"	0.375	11-3/4"	7-1/8"	#3 Taper	Bridge - Spiral	\$148.56
AFF-5264	13/16"	0.468	12"	7-3/8"	#3 Taper	Bridge - Spiral	\$149.84
AFF-6064	15/16"	0.585	12"	7-3/8"	#3 Taper	Bridge - Spiral	\$181.86
AFF-6864	1-1/16"	0.807	12"	7-3/8"	#3 Taper	Bridge - Spiral	\$245.23





1" Cutting Depth



2" Cutting Depth

1" HSS Annular Cutter

Part #	Size	x	Depth	List
100MC2864	7/16"	X	1"	\$50.71
100MC3264	1/2"	X	1"	\$50.71
100MC3664	9/16"	X	1"	\$53.01
100MC4064	5/8"	X	1"	\$57.18
100MC4464	11/16"	X	1"	\$61.50
100MC4864	3/4"	X	1"	\$62.87
100MC5264	13/16"	X	1"	\$70.02
100MC5664	7/8"	X	1"	\$76.00
100MC6064	15/16"	X	1"	\$78.69
100MC6464	1"	X	1"	\$88.05
100MC6864	1-1/16"	X	1"	\$102.12
100MC7264	1-1/8"	X	1"	\$111.67
100MC7664	1-3/16"	X	1"	\$113.97
100MC8064	1-1/4"	X	1"	\$116.13
100MC8464	1-5/16"	X	1"	\$133.80
100MC8864	1-3/8"	X	1"	\$153.08
100MC9264	1-7/16"	X	1"	\$170.71
100MC9664	1-1/2"	X	1"	\$201.00
100MC1916	1-9/16"	X	1"	\$205.61
100MC1058	1-5/8"	X	1"	\$208.16
100MC1116	1-11/16"	X	1"	\$210.07
100MC1034	1-3/4"	X	1"	\$214.18
100MC1316	1-13/16"	X	1"	\$221.48
100MC1078	1-7/8"	X	1"	\$230.74
100MC1516	1-15/16"	X	1"	\$239.27
100MC2002	2"	X	1"	\$280.48
100MC2116	2-1/16"	X	1"	\$452.71

2" HSS Annular Cutter

Part #	Size	x	Depth	List
200MC2864	7/16"	X	2"	\$68.65
200MC3264	1/2"	X	2"	\$68.65
200MC3664	9/16"	X	2"	\$70.95
200MC4064	5/8"	X	2"	\$78.79
200MC4464	11/16"	X	2"	\$87.63
200MC4864	3/4"	X	2"	\$93.05
200MC5264	13/16"	X	2"	\$102.12
200MC5664	7/8"	X	2"	\$118.62
200MC6064	15/16"	X	2"	\$120.54
200MC6464	1"	X	2"	\$124.53
200MC6864	1-1/16"	X	2"	\$129.17
200MC7264	1-1/8"	X	2"	\$157.19
200MC7664	1-3/16"	X	2"	\$163.56
200MC8064	1-1/4"	X	2"	\$179.59
200MC8464	1-5/16"	X	2"	\$194.33
200MC8864	1-3/8"	X	2"	\$210.95
200MC9264	1-7/16"	X	2"	\$225.20
200MC9664	1-1/2"	X	2"	\$232.51
200MC1916	1-9/16"	X	2"	\$267.39
200MC1058	1-5/8"	X	2"	\$276.95
200MC1116	1-11/16"	X	2"	\$288.66
200MC1034	1-3/4"	X	2"	\$300.08
200MC1316	1-13/16"	X	2"	\$312.75
200MC1078	1-7/8"	X	2"	\$325.05
200MC1516	1-15/16"	X	2"	\$367.79
200MC2002	2"	X	2"	\$386.51
200MC2116	2-1/16"	X	2"	\$554.09

- ◆ M2 HSS
- ◆ 3/4" Weldon Shanks
- ◆ Aggressive Cutting Edges
- ◆ No Center Punch Required
- ◆ Cut up to 2"
- ◆ For All Magnetic Drills

- Steel
- Stainless Steel
- Castings



ENGLAND



Allows overlap cut on existing holes



Pilot Pins

Part #	Description	List
PJ00011	Pilot 1" Cutter	\$12.95
PJ00021	Pilot 2" Cutter	\$15.75
PJ00716	Pilot 7/16" x 1" Cutter <b>ONLY</b>	\$12.95
PJ02716	Pilot 7/16" x 2" Cutter <b>ONLY</b>	\$15.75



Arbor Adapters

Part #	Description	List
AD0002	Morse #2	\$370.30
AD0003	Morse #3	\$380.03

Converts Morse Tapers to 3/4" Arbor for All **ITM** and Conventional Annular Cutters.



**1-3/8" Cutting Depth**

**1-3/8" TCT Annular Cutter**

Part #	Size	x	Depth	List
ATAC-3264	1/2"	X	1-3/8"	\$95.87
ATAC-3664	9/16"	X	1-3/8"	\$97.92
ATAC-4064	5/8"	X	1-3/8"	\$98.86
ATAC-4464	11/16"	X	1-3/8"	\$99.65
ATAC-4864	3/4"	X	1-3/8"	\$100.79
ATAC-5264	13/16"	X	1-3/8"	\$102.25
ATAC-5664	7/8"	X	1-3/8"	\$105.73
ATAC-6064	15/16"	X	1-3/8"	\$106.95
ATAC-6464	1"	X	1-3/8"	\$110.15
ATAC-6864	1-1/16"	X	1-3/8"	\$118.32
ATAC-7264	1-1/8"	X	1-3/8"	\$120.26
ATAC-8864	1-3/8"	X	1-3/8"	\$141.95
ATAC-9264	1-7/16"	X	1-3/8"	\$162.80
ATAC-9664	1-1/2"	X	1-3/8"	\$165.90

**2" Cutting Depth**

**2" TCT Annular Cutter**

Part #	Size	x	Depth	List
BTAC-3264	1/2"	X	2"	\$108.19
BTAC-3664	9/16"	X	2"	\$108.81
BTAC-4064	5/8"	X	2"	\$109.17
BTAC-4464	11/16"	X	2"	\$111.62
BTAC-4864	3/4"	X	2"	\$113.41
BTAC-5264	13/16"	X	2"	\$114.53
BTAC-5664	7/8"	X	2"	\$116.31
BTAC-6064	15/16"	X	2"	\$118.38
BTAC-6464	1"	X	2"	\$120.26
BTAC-6864	1-1/16"	X	2"	\$132.52
BTAC-7264	1-1/8"	X	2"	\$133.61
BTAC-8864	1-3/8"	X	2"	\$158.09
BTAC-9264	1-7/16"	X	2"	\$179.78
BTAC-9664	1-1/2"	X	2"	\$186.30
BTAC-2002	2"	X	2"	\$255.54



- ◆ Tungsten Carbide Teeth
- ◆ 3/4" Weldon Shanks
- ◆ Aggressive Cutting Edges
- ◆ No Center Punch Required
- ◆ For All Magnetic Drills

- Steel
- Stainless Steel
- Castings



**3" Cutting Depth**

**3" TCT Annular Cutter**

Part #	Size	x	Depth	List
CTAC-3264	1/2"	X	3"	\$159.13
CTAC-3664	9/16"	X	3"	\$162.00
CTAC-4064	5/8"	X	3"	\$170.62
CTAC-4464	11/16"	X	3"	\$174.35
CTAC-4864	3/4"	X	3"	\$180.17
CTAC-5264	13/16"	X	3"	\$182.26
CTAC-5664	7/8"	X	3"	\$185.12
CTAC-6064	15/16"	X	3"	\$187.53
CTAC-6464	1"	X	3"	\$191.22
CTAC-6864	1-1/16"	X	3"	\$208.90
CTAC-7264	1-1/8"	X	3"	\$211.82
CTAC-8864	1-3/8"	X	3"	\$234.77
CTAC-9664	1-1/2"	X	3"	\$285.27
CTAC-2002	2"	X	3"	\$382.19

**4" Cutting Depth**

**4" TCT Annular Cutter**

Part #	Size	x	Depth	List
RTAC-4864	3/4"	X	4"	\$218.39
RTAC-5264	13/16"	X	4"	\$218.39
RTAC-5664	7/8"	X	4"	\$218.39
RTAC-6064	15/16"	X	4"	\$218.39
RTAC-6464	1"	X	4"	\$218.39
RTAC-6864	1-1/16"	X	4"	\$249.83
RTAC-7264	1-1/8"	X	4"	\$249.83
RTAC-8864	1-3/8"	X	4"	\$285.27
RTAC-9664	1-1/2"	X	4"	\$353.55
RTAC-1058	1-5/8"	X	4"	\$399.96
RTAC-1034	1-3/4"	X	4"	\$399.96
RTAC-2002	2"	X	4"	\$470.94

Similar to Annular Cutters, designed with Tungsten Carbide Teeth (TCT) for much faster deep drilling.



Allows overlap cut on existing holes

- **Cut Faster**
- **Cut Cleaner**
- **Lasts Longer**

**Pilot Pins**

Part #	Depth	Cutter	List
PT-10	1-3/8"	1/2" - 5/8"	\$12.59
PT-12	1-3/8"	11/16" - 1-1/2"	\$11.49
PT-20	2"	1/2" - 5/8"	\$12.59
PT-22	2"	11/16" - 2"	\$13.40
PT-30	3"	1/2" - 5/8"	\$18.39
PT-32	3"	11/16" - 2"	\$20.67
PT-40	4"	3/4" - 2"	\$25.72





3/16" Cutting Depth



1/2" Cutting Depth

**T.C.T. Hole Cutter**

Part #	Size	Cut	Shank	List
HF0012	5/8"	3/16"	3/8"	\$31.50
HF0013	11/16"	3/16"	3/8"	\$31.50
HF0014	3/4"	3/16"	3/8"	\$35.02
HF0015	13/16"	3/16"	3/8"	\$35.02
HF0016	7/8"	3/16"	3/8"	\$35.02
HF0017	15/16"	3/16"	3/8"	\$35.02
HF0018	1"	3/16"	3/8"	\$35.02
HF0119	1-1/16"	3/16"	3/8"	\$38.89
HF0019	1-1/8"	3/16"	3/8"	\$38.89
HF0021	1-1/4"	3/16"	3/8"	\$45.00
HF0023	1-3/8"	3/16"	3/8"	\$45.00
HF0024	1-1/2"	3/16"	3/8"	\$52.22
HF0025	1-5/8"	3/16"	3/8"	\$61.25
HF0026	1-3/4"	3/16"	3/8"	\$61.25
HF0027	1-7/8"	3/16"	3/8"	\$62.00
HF0028	2"	3/16"	3/8"	\$69.50
HF0029	2-1/8"	3/16"	3/8"	\$69.50
HF0030	2-1/4"	3/16"	3/8"	\$87.78
HF0032	2-3/8"	3/16"	3/8"	\$87.78
HF0033	2-1/2"	3/16"	1/2"	\$103.89
HF0135	2-3/4"	3/16"	1/2"	\$111.67
HF0035	3"	3/16"	1/2"	\$123.50
HF0138	3-1/4"	3/16"	1/2"	\$138.81
HF0036	3-1/2"	3/16"	1/2"	\$148.83
HF0140	3-5/8"	3/16"	1/2"	\$168.13
HF0037	4"	3/16"	1/2"	\$175.00

**T.C.T. Hole Cutter**

Part #	Size	Cut	Shank	List
HG0011	9/16"	1/2"	3/8"	\$41.67
HG0012	5/8"	1/2"	3/8"	\$41.67
HG0013	11/16"	1/2"	3/8"	\$41.67
HG0014	3/4"	1/2"	3/8"	\$46.75
HG0015	13/16"	1/2"	3/8"	\$46.75
HG0016	7/8"	1/2"	3/8"	\$46.75
HG0017	15/16"	1/2"	3/8"	\$46.75
HG0018	1"	1/2"	3/8"	\$46.75
HG0119	1-1/16"	1/2"	3/8"	\$54.17
HG0019	1-1/8"	1/2"	3/8"	\$54.17
HG0020	1-3/16"	1/2"	3/8"	\$54.17
HG0021	1-1/4"	1/2"	3/8"	\$63.19
HG0023	1-3/8"	1/2"	3/8"	\$63.19
HG0024	1-1/2"	1/2"	3/8"	\$72.92
HG0025	1-5/8"	1/2"	3/8"	\$84.72
HG0026	1-3/4"	1/2"	3/8"	\$84.72
HG0027	1-7/8"	1/2"	3/8"	\$84.94
HG0028	2"	1/2"	3/8"	\$94.72
HG0029	2-1/8"	1/2"	3/8"	\$94.72
HG0030	2-1/4"	1/2"	3/8"	\$108.17
HG0032	2-3/8"	1/2"	3/8"	\$108.17
HG0033	2-1/2"	1/2"	1/2"	\$127.11
HG0135	2-3/4"	1/2"	1/2"	\$137.50
HG0035	3"	1/2"	1/2"	\$159.50
HG0138	3-1/4"	1/2"	1/2"	\$162.78
HG0036	3-1/2"	1/2"	1/2"	\$174.44
HG0037*	4"	1/2"	1/2"	\$215.11
HG0040*	4-1/2"	1/2"	1/2"	\$249.24
HG0050*	5"	1/2"	1/2"	\$265.25

\* Use Pilot Part# HG-PILOT2

- ◆ Excellent Wear and Heat Resistance
- ◆ Tungsten Carbide Teeth
- ◆ Cuts Stainless Steel and Tough Alloys
- ◆ Ejects the Slug Saving Time
- ◆ Works in 3/8" & 1/2" Chucks
- ◆ Made In Taiwan

- ➔ Sheet Metal
- ➔ Steel Plate
- ➔ Stainless Steel
- ➔ Copper
- ➔ Cast Iron



T.C.T. HOLE CUTTERS ARE SOLD INDIVIDUALLY.

- **Cut Faster**

- **Cut Cleaner**

- **Lasts Longer**

**TUNGSTEN CARBIDE TEETH**

Size	Steel (rpm)	Stainless Steel (rpm)
9/16" to 13/16"	700-1000	300-700
7/8" to 1-3/16"	500-800	200-450
1-1/4" to 1-9/16"	300-600	175-315
1-5/8" to 2"	200-500	120-225
2-1/16" to 2-3/8"	200-400	95-195
2-7/16" to 3"	150-300	80-150
3-1/16" to 5"	100-200	60-120



1-3/8" Cutting Depth

### T.C.T. Hole Cutter

Part #	Size	Cut	Shank	List
HM0011	9/16"	1-3/8"	1/2"	\$81.11
HM0012	5/8"	1-3/8"	1/2"	\$81.11
HM0013	11/16"	1-3/8"	1/2"	\$81.11
HM0014	3/4"	1-3/8"	1/2"	\$81.11
HM0015	13/16"	1-3/8"	1/2"	\$81.11
HM0016	7/8"	1-3/8"	1/2"	\$81.11
HM0017	15/16"	1-3/8"	1/2"	\$81.11
HM0018	1"	1-3/8"	1/2"	\$81.11
HM0119	1-1/16"	1-3/8"	1/2"	\$93.89
HM0019	1-1/8"	1-3/8"	1/2"	\$93.89
HM0020	1-3/16"	1-3/8"	1/2"	\$93.89
HM0021	1-1/4"	1-3/8"	1/2"	\$110.00
HM0023	1-3/8"	1-3/8"	1/2"	\$110.00
HM0024	1-1/2"	1-3/8"	1/2"	\$127.78
HM0025	1-5/8"	1-3/8"	1/2"	\$148.33
HM0026	1-3/4"	1-3/8"	1/2"	\$148.33
HM0027	1-7/8"	1-3/8"	1/2"	\$168.33
HM0028	2"	1-3/8"	1/2"	\$188.33
HM0029	2-1/8"	1-3/8"	1/2"	\$188.33
HM0030	2-1/4"	1-3/8"	1/2"	\$213.89
HM0032	2-3/8"	1-3/8"	1/2"	\$213.89
HM0033	2-1/2"	1-3/8"	1/2"	\$252.22



- ◆ Excellent Wear and Heat Resistance
- ◆ Tungsten Carbide Teeth
- ◆ Cuts Stainless Steel and Tough Alloys
- ◆ Works in 1/2" Chucks
- ◆ Made In Taiwan

- Sheet Metal
- Steel Plate
- Stainless Steel
- Copper
- Cast Iron

**SHEET METAL  
STEEL PLATE  
STAINLESS STEEL**

**FOR USE IN 1/2"  
CHUCK DRILLS**



T.C.T. HOLE CUTTERS ARE SOLD INDIVIDUALLY.

**POW!**



2" Cutting Depth

### T.C.T. Steel Door Hole Cutter

Part #	Size	Cut	Shank	List
HP0014	3/4"	2"	1/2"	\$75.00
HP0018	1"	2"	1/2"	\$75.00
HP0021	1-1/4"	2"	1/2"	\$101.39
HP0029	2-1/8"	2"	1/2"	\$172.92

- ◆ Made for Door Knob and Lock Installation
- ◆ Tungsten Carbide Teeth
- ◆ Works in 1/2" Chucks
- ◆ Made In Taiwan



### Replacement Parts

Part #	Description	List
HF-PILOT	CENTER DRILL φ6mm x 50L	\$8.25
HF-S	SPRING 1.2MM X 16L	\$0.75
HG-PILOT	CENTER DRILL φ6mm x 60L	\$9.45
HG-PILOT2	CENTER DRILL φ8mm x 60L	\$9.45
HG-S	SPRING 1.2MM X 23L	\$0.75
HM-PILOT	CENTER DRILL φ6mm x 75L	\$11.11
HM-S	SPRING 1.2MM X 50L	\$2.10
HP-PILOT	CENTER DRILL φ6mm x 90L	\$12.50
HP-S	SPRING 1.2MM X 60L	\$0.75



- ◆ Excellent Wear and Heat Resistance
- ◆ Tungsten Carbide Teeth
- ◆ Cuts Stainless Steel and Tough Alloys
- ◆ Works in 1/2" Chucks
- ◆ Made In Taiwan

- Sheet Metal
- Steel Plate
- Stainless Steel
- Copper
- Cast Iron



### Roto Plate Cutter

Part #	Size	X	OAL	Drilling	Shank	Qty.	List
RPC-14	7/8"	X	14-1/2"	1-3/8"	1/2"	1	\$143.92
RPC-16	1"	X	14-1/2"	1-3/8"	1/2"	1	\$143.92
RPC-19	1-1/8"	X	14-1/2"	1-3/8"	1/2"	1	\$161.81
RPC-20	1-1/4"	X	14-1/2"	1-3/8"	1/2"	1	\$184.36
RPC-24	1-1/2"	X	14-1/2"	1-3/8"	1/2"	1	\$201.78
RPC-28	1-3/4"	X	14-1/2"	1-3/8"	1/2"	1	\$229.53
RPC-32	2"	X	14-1/2"	1-3/8"	1/2"	1	\$283.53
RPC-36	2-1/4"	X	14-1/2"	1-3/8"	1/2"	1	\$318.03
RPC-40	2-1/2"	X	14-1/2"	1-3/8"	1/2"	1	\$356.08
RPC-18EX	18" Extension				1/2"	1	\$44.05

**SHEET METAL  
STEEL PLATE  
STAINLESS STEEL**

**FOR USE IN 1/2"  
CHUCK DRILLS**

*Reach the Impossible...*



## Bi-Metal Hole Saws - Variable Pitch

Part #	Dia. Inches	Dia. MM	PIPE TAP SIZE		PIPE ENT. SIZE		Use	
			Inches	MM	Inches	MM	Arbor	List
275HW0011	9/16"	14.3	3/8"				*	\$14.58
275HW0012	5/8"	15.5					*	\$11.07
275HW0112	16mm	16.0					*	\$14.00
275HW0013	11/16"	17.5					*	\$11.07
275HW0014	3/4"	19.0	1/2"	13 mm	3/8"	10 mm	*	\$11.07
275HW0114	20mm	20.0					*	\$14.00
275HW0015	13/16"	20.6					*	\$11.07
275HW0016	7/8"	22.2	3/4"	19 mm	1/2"	13 mm	*	\$11.07
275HW0017	15/16"	23.8					*	\$11.07
275HW0117	25mm	25.0					*	\$14.85
275HW0018	1"	25.4					*	\$11.74
275HW0185	1-1/16"	27.0					*	\$11.74
275HW0019	1-1/8"	28.8	1"	25 mm	3/4"	19 mm	*	\$11.74
275HW0118	30mm	30.0					*	\$14.85
275HW0020	1-3/16"	30.2					*	\$11.74
275HW0021	1-1/4"	31.8					**	\$11.74
275HW0121	32mm	32.0					**	\$15.41
275HW0022	1-5/16"	33.3					**	\$11.74
275HW0023	1-3/8"	34.9			1"	25 mm	**	\$12.45
275HW0122	35mm	35.0					**	\$17.01
275HW0123	1-7/16"	36.5					**	\$12.45
275HW0024	1-1/2"	38.1	1-1/4"	32 mm			**	\$12.69
275HW0124	1-9/16"	39.7					**	\$12.69
275HW0224	40mm	40.0					**	\$17.54
275HW0025	1-5/8"	41.2					**	\$12.84
275HW0125	1-11/16"	42.9					**	\$12.84
275HW0026	1-3/4"	44.5	1-1/2"	38 mm	1-1/4"	32 mm	**	\$15.55
275HW0226	45mm	45.0					**	\$21.25
275HW0126	1-13/16"	46.0					**	\$15.55
275HW0027	1-7/8"	47.6					**	\$15.78
275HW0127	50mm	50.0					**	\$21.88
275HW0028	2"	50.8			1-1/2"	38 mm	**	\$17.06
275HW0128	2-1/16"	52.4					**	\$19.13
275HW0029	2-1/8"	53.9					**	\$19.13
275HW0129	55mm	55.0					**	\$26.14
275HW0030	2-1/4"	57.2	2"	51 mm			**	\$19.28
275HW0031	2-5/16"	58.7					**	\$19.45
275HW0032	2-3/8"	60.3					**	\$19.55
275HW0033	2-1/2"	63.5			2"	51 mm	**	\$20.62
275HW0034	2-9/16"	65.1					**	\$20.74
275HW0134	2-5/8"	66.7	2-1/2"	64 mm			**	\$21.22
275HW0234	68mm	68.0					**	\$28.99
275HW0334	68.5mm	68.5					**	\$28.99
275HW0135	2-3/4"	69.9					**	\$21.22
275HW0136	2-7/8"	73.0					**	\$21.22
275HW0236	75mm	75.0					**	\$28.99
275HW0035	3"	76.2			2-1/2"	64 mm	**	\$21.22
275HW0137	3-1/8"	79.4					**	\$21.44
275HW0138	3-1/4"	82.6	3"	76 mm			**	\$21.44
275HW0139	3-3/8"	85.7					**	\$21.44
275HW0036	3-1/2"	88.9					**	\$21.44
275HW0140	3-5/8"	92.1			3"	76 mm	**	\$25.17
275HW0141	3-3/4"	95.3	3-1/2"	89 mm			**	\$29.57
275HW0142	3-7/8"	98.4					**	\$31.10
275HW0100	100mm	100.0					**	\$38.79
275HW0037	4"	101.6					**	\$32.44
275HW0143	4-1/8"	104.8			3-1/2"	89 mm	**	\$35.49
275HW0144	4-1/4"	108.0	4"	102 mm			**	\$46.19
275HW0038	4-1/2"	114.3			4"	102 mm	**	\$63.89
275HW0145	4-3/4"	120.7	4-1/2"				**	\$74.03
275HW0039	5"	127.0					**	\$78.72
275HW0040	5-1/2"	139.7					**	\$93.93
275HW0146	5-3/4"	146.0					**	\$101.99
275HW0041	6"	152.4					**	\$110.04



1 HOLE SAW PER BOX.  
ARBOR NOT INCLUDED.



These High Quality Bi-Metal Hole Saws are made by a very special process. The cutting edge is electron beam welded to a tough alloy steel back. These hole saws are ideal for work where high performance & accuracy are needed. Saws have knock-out holes for easy core removal.

- ◆ Made In USA
- ◆ Bi-Metal Construction
- ◆ M3 Cutting Edge
- ◆ 5 Variable Pitch. Rc. 63-65
- ◆ Positive Rake
- ◆ 1-15/16" Cutting Depth
- ◆ Premium Quality
- ◆ Cuts Through 2" x 4"s
- ◆ Red Finish

- ➔ Wood
- ➔ Plastic
- ➔ Machinable Metal
- ➔ Nail Embedded Wood
- ➔ Plywood
- ➔ Pipes
- ➔ Light Gauge Stainless Steel

\* USE ARBORS ARB-0, ARB-1 or ARB-2.  
\*\* USE ARBORS ARB-3, ARB-4 or ARB-5.



1 HOLE SAW PER BOX.  
ARBOR NOT INCLUDED.

These High Quality Carbide Tipped Hole Saws are designed for use in abrasive materials such as particle board, fiberglass, cast iron, asbestos board, and formica. They are ideal for work where high performance & accuracy are needed. Saws have knock-out holes for easy core removal.

**Made In**



- ◆ Made In USA
- ◆ Tungsten Carbide Teeth
- ◆ Ground & Welded Set Teeth
- ◆ 3 Teeth Per Inch
- ◆ High Wear Resistance
- ◆ 1-1/2" Cutting Depth
- ◆ Premium Quality
- ◆ Black Finish

- Particle Board
- Fiberglass
- Cast Iron
- Asbestos Board
- Formica

\* USE ARBORS ARB-0, ARB-1, ARB-2 or ARB-5.  
\*\* USE ARBORS ARB-3, ARB-4, ARB-5 or ARB-9.

## Carbide Tipped Hole Saws

Part #	Dia.		PIPE TAP SIZE		PIPE ENT. SIZE		Use	
	Inches	MM	Inches	MM	Inches	MM	Arbor	List
AT120034	3/4"	19.0	1/2"	13 mm	3/8"	10 mm	*	\$19.63
AT131316	13/16"	20.6					*	\$19.99
AT140078	7/8"	22.2	3/4"	19 mm	1/2"	13 mm	*	\$20.25
AT151516	15/16"	23.8					*	\$20.95
AT160001	1"	25.4					*	\$21.56
AT171116	1-1/16"	27.0					*	\$22.33
AT180118	1-1/8"	28.8	1"	25 mm	3/4"	19 mm	*	\$22.85
AT191316	1-3/16"	30.2					*	\$23.67
AT200114	1-1/4"	31.8					**	\$23.79
AT211516	1-5/16"	33.3					**	\$23.79
AT220138	1-3/8"	34.9			1"	25 mm	**	\$24.19
AT231716	1-7/16"	36.5					**	\$24.25
AT240112	1-1/2"	38.1	1-1/4"	32 mm			**	\$24.76
AT251916	1-9/16"	39.7					**	\$25.69
AT260158	1-5/8"	41.2					**	\$26.26
AT271116	1-11/16"	42.9					**	\$27.50
AT280134	1-3/4"	44.5	1-1/2"	38 mm	1-1/4"	32 mm	**	\$27.50
AT291316	1-13/16"	46.0					**	\$28.08
AT300178	1-7/8"	47.6					**	\$28.65
AT320002	2"	50.8			1-1/2"	38 mm	**	\$29.52
AT332116	2-1/16"	52.4					**	\$34.15
AT340218	2-1/8"	53.9					**	\$34.74
AT360214	2-1/4"	57.2	2"	51 mm			**	\$35.93
AT372516	2-5/16"	58.7					**	\$36.62
AT380238	2-3/8"	60.3					**	\$37.14
AT400212	2-1/2"	63.5			2"	51 mm	**	\$38.80
AT412916	2-9/16"	65.1					**	\$39.10
AT420258	2-5/8"	66.7	2-1/2"	64 mm			**	\$40.08
AT440234	2-3/4"	69.9					**	\$41.28
AT460278	2-7/8"	73.0					**	\$42.54
AT480003	3"	76.2			2-1/2"	64 mm	**	\$43.75
AT500318	3-1/8"	79.4					**	\$52.73
AT520314	3-1/4"	82.6	3"	76 mm			**	\$53.64
AT540338	3-3/8"	85.7					**	\$57.01
AT560312	3-1/2"	88.9					**	\$58.21
AT580358	3-5/8"	92.1			3"	76 mm	**	\$59.41
AT600334	3-3/4"	95.3	3-1/2"	89 mm			**	\$61.08
AT620378	3-7/8"	98.4					**	\$61.83
AT640004	4"	101.6					**	\$64.93
AT660418	4-1/8"	104.8			3-1/2"	89 mm	**	\$90.13
AT680414	4-1/4"	108.0	4"	102 mm			**	\$93.39
AT700438	4-3/8"	111.0					**	\$94.56
AT720412	4-1/2"	114.3			4"	102 mm	**	\$95.07
AT760434	4-3/4"	120.7					**	\$103.52
AT800005	5"	127.0					**	\$106.57
AT880512	5-1/2"	139.7					**	\$112.23
AT920534	5-3/4"	146.0					**	\$114.99
AT960006	6"	152.4					**	\$118.05

## CARBIDE TIPPED RPM CHART

SIZE	ALUMINUM	PLASTIC	FIBER-GLASS	CERAMIC TILE	PARTICLE BOARD	CAST IRON	FORMICA
3/4"	1700	3430	250	500	3430	410	210
7/8"	1500	2940	210	430	2940	350	180
1"	1300	2570	190	370	2570	310	150
1-1/8"	1100	2290	170	330	2290	270	140
1-3/8"	900	1870	140	270	1870	220	110
1-1/2"	900	1710	120	250	1710	210	100
1-3/4"	700	1470	110	210	1470	180	90
2"	600	1290	90	190	1290	150	80
2-1/4"	600	1140	80	170	1140	140	70
2-1/2"	500	1030	70	150	1030	120	60
3"	400	860	60	120	860	100	50
3-1/4"	400	790	60	110	790	90	50
3-5/8"	400	710	50	100	710	90	40
3-3/4"	300	690	50	100	690	80	40
4-1/8"	300	620	50	90	620	70	40
4-3/4"	300	540	40	80	540	60	30
5"	200	480	40	80	500	60	30
5-1/2"	200	420	40	70	460	50	30
6"	100	360	30	60	420	40	30

## Carbide Grit Hole Saws

Part #	Dia.		PIPE TAP SIZE		PIPE ENT. SIZE		Use	
	Inches	MM	Inches	MM	Inches	MM	Arbor	List
CG0012	3/4"	19.0	1/2"	13 mm	3/8"	10 mm	*	\$41.81
CG0013	13/16"	20.6					*	\$41.81
CG0014	7/8"	22.2	3/4"	19 mm	1/2"	13 mm	*	\$41.81
CG0015	15/16"	23.8					*	\$41.81
CG0016	1"	25.4					*	\$45.66
CG0017	1-1/16"	27.0					*	\$45.66
CG0018	1-1/8"	28.8	1"	25 mm	3/4"	19 mm	*	\$45.66
CG0019	1-3/16"	30.2					*	\$45.66
CG0020	1-1/4"	31.8					**	\$46.85
CG0021	1-5/16"	33.3					**	\$46.85
CG0022	1-3/8"	34.9			1"	25 mm	**	\$47.23
CG0023	1-7/16"	36.5					**	\$47.23
CG0024	1-1/2"	38.1	1-1/4"	32 mm			**	\$47.23
CG0025	1-9/16"	39.7					**	\$47.23
CG0026	1-5/8"	41.2					**	\$47.23
CG0027	1-11/16"	42.9					**	\$47.23
CG0028	1-3/4"	44.5	1-1/2"	38 mm	1-1/4"	32 mm	**	\$57.94
CG0029	1-13/16"	46.0					**	\$57.94
CG0030	1-7/8"	47.6					**	\$57.94
CG0032	2"	50.8			1-1/2"	38 mm	**	\$57.94
CG0033	2-1/16"	52.4					**	\$57.94
CG0034	2-1/8"	53.9					**	\$68.56
CG0036	2-1/4"	57.2	2"	51 mm			**	\$68.56
CG0037	2-5/16"	58.7					**	\$68.56
CG0038	2-3/8"	60.3					**	\$68.56
CG0040	2-1/2"	63.5			2"	51 mm	**	\$77.28
CG0041	2-9/16"	65.1					**	\$77.28
CG0042	2-5/8"	66.7	2-1/2"	64 mm			**	\$77.28
CG0044	2-3/4"	69.9					**	\$77.28
CG0046	2-7/8"	73.0					**	\$77.28
CG0048	3"	76.2			2-1/2"	64 mm	**	\$93.64
CG0050	3-1/8"	79.4					**	\$93.64
CG0052	3-1/4"	82.6	3"	76 mm			**	\$93.64
CG0054	3-3/8"	85.7					**	\$93.64
CG0056	3-1/2"	88.9					**	\$99.44
CG0058	3-5/8"	92.1			3"	76 mm	**	\$107.04
CG0060	3-3/4"	95.3	3-1/2"	89 mm			**	\$115.28
CG0062	3-7/8"	98.4					**	\$119.06
CG0064	4"	101.6					**	\$123.46
CG0066	4-1/8"	104.8			3-1/2"	89 mm	**	\$132.14
CG0068	4-1/4"	108.0	4"	102 mm			**	\$138.78
CG0070	4-3/8"	111.0					**	\$145.66
CG0072	4-1/2"	114.3			4"	102 mm	**	\$152.16
CG0076	4-3/4"	120.7					**	\$162.84
CG0080	5"	127.0					**	\$174.22
CG0088	5-1/2"	139.7					**	\$186.42
CG0092	5-3/4"	146.0					**	\$186.42
CG0096	6"	152.4					**	\$186.42



1 HOLE SAW PER BOX.  
ARBOR NOT INCLUDED.

These High Quality Carbide Grit Hole Saws are designed for use in hard or abrasive materials such as ceramics, fiberglass, hard woods, cast iron, & composites. They are best suited for thin materials that would strip bi-metal or carbide teeth. Saws have knock-out holes for easy core removal. Use a carbide tipped pilot arbor when drilling ceramics.

### Made In



- ◆ Made In USA
- ◆ Tungsten Carbide Grit
- ◆ Bonded to Alloy Back
- ◆ Gulletted Edge
- ◆ Super Wear Resistance
- ◆ 1-3/8" Cutting Depth
- ◆ Premium Quality
- ◆ Black Finish

- Ceramics
- Fiberglass
- Cast Iron
- Hard Woods
- Composites



## CARBIDE GRIT

### RECESSED LIGHTING HOLE SAWS

Part#	Size	List
CG0104	6-3/8"	\$196.85
CG0110	6-7/8"	\$196.85

\* USE ARBORS ARB-0, ARB-1, ARB-2 or ARB-8.  
\*\* USE ARBORS ARB-3, ARB-4, ARB-5 or ARB-9.





### 1/4" Pilot Drills

- ◆ Industrial Quality
- ◆ High Speed Steel
- ◆ Designed For Arbors
- ◆ HSS Sold 10/ Pack
- ◆ Carbide Sold Individually



**PART #**  
**277PD0014**  
 1/4" HSS PILOT DRILL  
 3 STEPS  
 List \$2.51



**PART #**  
**277PD0016**  
 1/4" HSS PILOT DRILL  
 3 FLATS  
 List \$2.51



**PART #**  
**277PD0018**  
 1/4" HSS PILOT DRILL  
 1 FLAT  
 List \$2.75



**PART #**  
**277PD0020**  
 1/4" CARBIDE PILOT DRILL  
 2-7/8" LONG 1 FLAT  
 List \$6.80



**PART #**  
**277PD0022**  
 1/4" CARBIDE PILOT DRILL  
 4" LONG 1 FLAT  
 List \$7.14

### Extension

**PART #**  
**EXT001**  
 12" Arbor Extension

For 7/16" Hex Shank Arbors Only!!!

List \$23.15

**PART #**  
**EXT002**  
 12" Arbor Extension

For 3/8" Hex Shank Arbors Only!!!

List \$23.15



3/8" Hex Shank

### Arbor Adapter Nut

**PART #**  
**NUT001**

Adapter Nut

Turns 1/2"-20 Thread To 5/8"-18 Thread



List \$6.65

Adapter nut allows smaller arbors without pins to fit larger hole saws. Not recommended for use with hole saws larger than 2-1/2".

Will work with any of the following 1/2"-20 threaded arbors:

- ARB-0
- ARB-1
- ARB-2
- ARB-8

## Arbors - With Pilot Drills

- ◆ High Quality
- ◆ Sold Individually in White Boxes
- ◆ Includes one 3-Flats HSS Pilot Drill

### FOR USE WITH:

- Bi-Metal Hole Saws
- Carbide Tipped Hole Saws
- Carbide Grit Hole Saws

**PART #**  
**ARB-0**  
1/4" 3-FLAT SHANK  
ARBOR FOR HOLE SAWS  
9/16" - 1-3/16"  
List \$11.14



**PART #**  
**ARB-1**  
1/4" HEX POWER SHANK  
ARBOR FOR HOLE SAWS  
9/16" - 1-3/16"  
List \$12.50



**PART #**  
**ARB-2**  
3/8" HEX POWER SHANK  
ARBOR FOR HOLE SAWS  
9/16" - 1-3/16"  
List \$15.95



**PART #**  
**ARB-3**  
3/8" HEX POWER SHANK  
FOR HOLE SAWS  
1-1/4" - 6"  
List \$15.95



**PART #**  
**ARB-4**  
3/8" HEX POWER SHANK  
ARBOR FOR HOLE SAWS  
1-1/4" - 6"  
List \$24.50



**PART #**  
**ARB-5**  
7/16" HEX POWER SHANK  
FOR HOLE SAWS  
1-1/4" - 6"  
List \$24.50



**PART #**  
**ARB-8**  
3/8" HEX POWER SHANK  
FOR HOLE SAWS  
3/4" - 1-3/16"  
List \$27.79



**PART #**  
**ARB-9**  
7/16" HEX POWER SHANK  
FOR HOLE SAWS  
1-1/4" - 6"  
List \$35.04



Use Arbors with Carbide Tipped Pilots when drilling with Carbide Tipped Hole Saws & Carbide Grit Hole Saws.



BI-METAL

**PART # 275AV02E  
ELECTRICIAN'S HOLE SAW KIT**

8 Pc. Set contains:  
1 each 7/8" - 1-1/8" - 1-3/8" - 1-3/4" - 2" - 2-1/2"  
2 Arbors - ARB-2 - ARB-5

PRICE EACH \$131.73



BI-METAL

**PART # 275AV100  
MAINTENANCE HOLE SAW KIT**

11 Pc. Set contains:  
1 each 3/4" - 7/8" - 1-1/8" - 1-3/8" - 1-1/2"  
1-3/4" - 2" - 2-1/4" - 2-1/2"  
2 Arbors - ARB-2 - ARB-5

PRICE EACH \$182.75



**PART # 275AT100  
CARBIDE TIPPED  
MAINTENANCE HOLE SAW KIT**

11 Pc. Set contains:  
1 each 3/4" - 7/8" - 1-1/8" - 1-3/8" - 1-1/2"  
1-3/4" - 2" - 2-1/4" - 2-1/2"  
2 Arbors - ARB-2 - ARB-5

PRICE EACH \$351.80



BI-METAL

**PART # 275AV08E  
MASTER ELECTRICIAN'S HOLE  
SAW KIT**

12 Pc. Set contains:  
1 each 7/8" - 1-1/8" - 1-3/8" - 1-3/4" - 2" - 2-1/2"  
3" - 3-5/8" - 4-1/8" - 4-1/2"  
2 Arbors - ARB-2 - ARB-5

PRICE EACH \$275.35



BI-METAL

**PART # 275AV04P  
PLUMBER'S HOLE SAW KIT**

8 Pc. Set contains:  
1 each 3/4" - 7/8" - 1-1/8" - 1-1/2" - 1-3/4" -  
2-1/4"  
2 Arbors - ARB-2 - ARB-5

PRICE EACH \$129.39

**RECOMMENDED  
Bi-Metal HOLE SAW  
CUTTING SPEEDS IN RPM'S**



- ① **LUBRICANTS** - Use a good cutting oil for faster, more efficient cutting in ferrous metals. Cutting oil should not be used when cutting cast iron. Beeswax or paraffin is often used when cutting aluminum.
- ② **CUTTING POSITION** - Do not cut materials at an angle. All the hole saw teeth should be in contact with the material to avoid tooth damage.
- ③ **FEEDS** - For effective cutting, apply level and even pressure. Excessive pressure results in premature wear, dulling of the teeth, and breakage. When cutting material over 1" thick, the saw should be pulled back at intervals to allow chip clearance.



SIZE	MILD STEEL	CAST IRON	TOOL & STAINLESS	BRASS	ALUMINUM
9/16"	580	400	300	790	900
5/8"	550	365	275	730	825
11/16"	500	330	250	665	750
3/4"	460	300	230	600	690
13/16"	425	280	210	560	635
7/8"	390	260	195	520	585
15/16"	370	245	185	495	555
1"	350	235	175	470	525
1 - 1/16"	325	215	160	435	480
1 - 1/8"	300	200	150	400	450
1 - 3/16"	285	190	145	380	425
1 - 1/4"	275	180	140	360	410
1 - 5/16"	260	175	135	345	390
1 - 3/8"	250	165	125	330	375
1 - 7/16"	240	160	120	315	360
1 - 1/2"	230	150	115	300	345
1 - 9/16"	220	145	110	290	330
1 - 5/8"	210	140	105	280	315
1 - 11/16"	205	135	100	270	305
1 - 3/4"	195	130	95	260	295
1 - 13/16"	190	125	95	250	285
1 - 7/8"	180	120	90	240	270
2"	170	115	85	230	255
2 - 1/16"	165	110	80	220	245
2 - 1/8"	160	105	80	210	240
2 - 1/4"	150	100	75	200	225
2 - 5/16"	145	100	75	195	225
2 - 3/8"	140	95	70	190	220
2 - 1/2"	135	90	65	180	205
2 - 9/16"	130	85	65	175	200
2 - 5/8"	130	85	65	170	195
2 - 3/4"	125	80	60	160	185
2 - 7/8"	120	80	60	160	180
3"	115	75	55	150	170
3 - 1/8"	110	70	55	140	165
3 - 1/4"	105	70	50	140	155
3 - 3/8"	100	65	50	130	150
3 - 1/2"	95	65	45	130	145
3 - 5/8"	95	60	45	120	140
3 - 3/4"	90	60	45	120	135
3 - 7/8"	90	60	45	120	135
4"	85	55	40	110	130
4 - 1/8"	80	55	40	110	120
4 - 1/4"	80	55	40	110	120
4 - 1/2"	75	50	35	100	105
4 - 3/4"	75	50	35	95	95
5"	65	45	30	90	90
5 - 1/2"	60	40	25	85	85
5 - 3/4"	55	35	25	75	75
6"	55	35	25	75	75



## All Purpose Reciprocating Blades - Bi-Metal

Part #	Blade Length	Teeth Per Inch	Description	Width / Length	Pack QTY.	List/ea.	Bulk (50 Pcs.) Part #	List/ea.
RB636W	6"	6T	Wood & Nail Slope	3/4" x 6" x .050"	5	\$3.64	BU-RB636W	\$3.21
RB656WS	6"	6T	Wood & Nail Scroll	3/4" x 6" x .050"	5	\$3.68	BU-RB656WS	\$3.35
RB956W	9"	6T	Wood & Nail	3/4" x 9" x .050"	5	\$5.10	BU-RB956W	\$4.81
RB125W	12"	6T	Wood & Nail	3/4" x 12" x .050"	5	\$6.56	BU-RB125W	\$6.27
RB414M	4"	14T	Metal	3/4" x 4" x .035"	5	\$2.10	BU-RB414M	\$2.04
RB418M	4"	18T	Metal	3/4" x 4" x .035"	5	\$2.10	BU-RB418M	\$2.04
RB424M	4"	24T	Metal	3/4" x 4" x .035"	5	\$2.10	BU-RB424M	\$2.04
RB610HDM	6"	10T	Metal	3/4" x 6" x .035"	5	\$2.56	BU-RB610HDM	\$2.48
RB614HDM	6"	14T	Metal	3/4" x 6" x .035"	5	\$2.56	BU-RB614HDM	\$2.48
RB618HDM	6"	18T	Metal	3/4" x 6" x .035"	5	\$2.56	BU-RB618HDM	\$2.48
RB624HDM	6"	24T	Metal	3/4" x 6" x .035"	5	\$2.56	BU-RB624HDM	\$2.48
RB810HDM	8"	10T	Metal 10/14 V.P.	3/4" x 8" x .035"	5	\$4.08	BU-RB810HDM	\$3.94
RB814HDM	8"	14T	Metal	3/4" x 8" x .035"	5	\$4.08	BU-RB814HDM	\$3.94
RB818HDM	8"	18T	Metal	3/4" x 8" x .035"	5	\$4.08	BU-RB818HDM	\$3.94
RB1010HDM	10"	10T	Metal	3/4" x 10" x .035"	5	\$5.78	BU-RB1010HDM	\$5.54
RB1018HDM	10"	18T	Metal	3/4" x 10" x .035"	5	\$5.78	BU-RB1018HDM	\$5.54
RB1218HDM	12"	18T	Metal	3/4" x 12" x .035"	5	\$6.56	BU-RB1218HDM	\$6.27
RB636DW	6"	6T	Drywall V Head	3/4" x 6" x .050"	5	\$3.65	BU-RB636DW	\$3.50
R8CCRF	8"	Carbide Grit	Cast Iron-Ceramic Tile	3/4" x 8" x .050"	1	\$11.55	BU-R8CCRF	\$10.21



### Made In



- ◆ Made In USA
- ◆ 1/2" Universal Shank
- ◆ Milled Teeth
- ◆ Matrix II Cutting Edge
- ◆ Tooth Hardness Rc 65-67
- ◆ 8% Cobalt
- ◆ Vacuum Heat Treatment
- ◆ Long Life
- ◆ Shock Resistant Teeth
- ◆ High Edge Hardness
- ◆ High Heat Resistance
- ◆ High Wear Resistance
- ◆ Greater Rigidity
- ◆ Resists Tooth Strippage
- ◆ Accepts Higher Feed Pressure



### Heavy Metal Reciprocating Blades - Bi-Metal

Part #	Blade Length	Teeth Per Inch	Description	Width / Length	Pack QTY.	List/ea.	Bulk (50 Pcs.) Part #	List/ea.
 HM610	6"	10T	Heavy Metal	1" x 6" x .042"	5	\$4.29	BU-HM610	\$4.02
 HM614	6"	14T	Heavy Metal	1" x 6" x .042"	5	\$4.29	BU-HM614	\$4.02
 HM618	6"	18T	Heavy Metal	1" x 6" x .042"	5	\$4.29	BU-HM618	\$4.02
 HM910	9"	10T	Heavy Metal	1" x 9" x .042"	5	\$5.74	BU-HM910	\$5.47
 HM914	9"	14T	Heavy Metal	1" x 9" x .042"	5	\$5.74	BU-HM914	\$5.47
 HM918	9"	18T	Heavy Metal	1" x 9" x .042"	5	\$5.74	BU-HM918	\$5.47
 HM1214	12"	14T	Heavy Metal	1" x 12" x .042"	5	\$6.84	BU-HM1214	\$6.57
 HM1218	12"	18T	Heavy Metal	1" x 12" x .042"	5	\$6.84	BU-HM1218	\$6.57



- ◆ Made In USA
- ◆ 1/2" Universal Shank
- ◆ Milled Teeth
- ◆ Bi-Metal
- ◆ Tooth Hardness Rc 65-67
- ◆ 8% Cobalt
- ◆ 1" Width
- ◆ 0.42" Thick
- ◆ Smooth Cutting
- ◆ High Edge Hardness
- ◆ High Heat Resistance
- ◆ High Wear Resistance
- ◆ Greater Rigidity
- ◆ Resists Tooth Strippage
- ◆ Accepts Higher Feed Pressure





### VIGOR™ Heavy Duty Reciprocating Blades - Bi-Metal

Part #	Blade Length	Teeth Per Inch	Description	Width / Length	Pack QTY.	List/ea.	Bulk (50 Pcs.) Part #	List/ea.
VIHD61014	6"	10/14 V.P.	Heavy Duty	3/4" x 6" x .050"	5	\$3.52	BU-VIHD61014	\$3.46
VIHD81014	8"	10/14 V.P.	Heavy Duty	3/4" x 8" x .050"	5	\$4.76	BU-VIHD81014	\$4.70
VIHD12014	12"	10/14 V.P.	Heavy Duty	3/4" x 12" x .050"	5	\$6.09	BU-VIHD12014	\$6.03

V.P. = Variable Pitch (Teeth)



### VIGOR™ Demolition Reciprocating Blades - Bi-Metal

Part #	Blade Length	Teeth Per Inch	Description	Width / Length	Pack QTY.	List/ea.	Bulk (25 Pcs.) Part #	List/ea.
VIDM60006	6"	6T	Demolition	7/8" x 6" x .062"	3	\$6.57	BU-VIDM60006	\$6.50
VIDM60010	6"	10T	Demolition	7/8" x 6" x .062"	3	\$6.57	BU-VIDM60010	\$6.50
VIDM90006	9"	6T	Demolition	7/8" x 9" x .062"	3	\$8.32	BU-VIDM90006	\$8.26
VIDM90010	9"	10T	Demolition	7/8" x 9" x .062"	3	\$8.32	BU-VIDM90010	\$8.26
VIDM12006	12"	6T	Demolition	7/8" x 12" x .062"	3	\$11.01	BU-VIDM12006	\$10.95
VIDM12010	12"	10T	Demolition	7/8" x 12" x .062"	3	\$11.01	BU-VIDM12010	\$10.95



- ◆ Made In USA
- ◆ 1/2" Universal Shank
- ◆ 45% Thicker Than All Purpose Blades

- ◆ Wider Than All Purpose Blades
- ◆ Stay Rigid
- ◆ No Vibration
- ◆ More Cuts Per Blade

**Tooth Style:**



Standard beveled configuration



10/14 Variable Pitch beveled configuration





# Retail Packs



## All Purpose Reciprocating Blades - Bi-Metal

Part #	Blade Length	Teeth Per Inch	Pack Description	Width / Length	QTY.	List/Pack
W636	6"	6T	Wood & Nail Slope	3/4" x 6" x .050"	5	\$19.76
W956	9"	6T	Wood & Nail	3/4" x 9" x .050"	5	\$27.67
W125	12"	6T	Wood & Nail	3/4" x 12" x .050"	5	\$35.57
M614	6"	14T	Metal	3/4" x 6" x .035"	5	\$14.82
M618	6"	18T	Metal	3/4" x 6" x .035"	5	\$14.82
M624	6"	24T	Metal	3/4" x 6" x .035"	5	\$14.82
M810	8"	10T	Metal	3/4" x 8" x .035"	5	\$22.14
M814	8"	14T	Metal	3/4" x 8" x .035"	5	\$22.14
M818	8"	18T	Metal	3/4" x 8" x .035"	5	\$22.14
M1218	12"	18T	Metal	3/4" x 12" x .035"	5	\$35.57

## VIGOR™ Heavy Duty and Demolition - Bi-Metal

Part #	Blade Length	Teeth Per Inch	Pack Description	Width / Length	QTY.	List/Pack
HD610	6"	10/14T	Heavy Duty	3/4" x 6" x .050"	5	\$18.22
HD810	8"	10/14T	Heavy Duty	3/4" x 8" x .050"	5	\$24.64
HD120	12"	10/14T	Heavy Duty	3/4" x 12" x .050"	5	\$31.54
DM606	6"	6T	Demolition	7/8" x 6" x .062"	3	\$20.39
DM610	6"	10T	Demolition	7/8" x 6" x .062"	3	\$20.39
DM906	9"	6T	Demolition	7/8" x 9" x .062"	3	\$25.84
DM910	9"	10T	Demolition	7/8" x 9" x .062"	3	\$25.84
DM1206	12"	6T	Demolition	7/8" x 12" x .062"	3	\$34.19
DM1210	12"	10T	Demolition	7/8" x 12" x .062"	3	\$34.19

- ◆ Made In USA
- ◆ Same Bi-Metal Blades p.59 & 61
- ◆ Slim-Line Retail Packs
- ◆ Price Per Pack



Rack  
P. 66

# Bulk Retail Packs



## All Purpose Reciprocating Blades - Bi-Metal

Part #	Blade Length	Teeth Per Inch	Pack Description	Width / Length	QTY.	List/Pack
W636-B	6"	6T	Wood & Nail Slope	3/4" x 6" x .050"	50	\$173.94
W956-B	9"	6T	Wood & Nail	3/4" x 9" x .050"	50	\$260.91
W125-B	12"	6T	Wood & Nail	3/4" x 12" x .050"	50	\$339.97
M614-B	6"	14T	Metal	3/4" x 6" x .035"	50	\$135.78
M618-B	6"	18T	Metal	3/4" x 6" x .035"	50	\$135.78
M624-B	6"	24T	Metal	3/4" x 6" x .035"	50	\$135.78
M810-B	8"	10T	Metal	3/4" x 8" x .035"	50	\$213.47
M814-B	8"	14T	Metal	3/4" x 8" x .035"	50	\$213.47
M818-B	8"	18T	Metal	3/4" x 8" x .035"	50	\$213.47
M1218-B	12"	18T	Metal	3/4" x 12" x .035"	50	\$339.97



## VIGOR™ Heavy Duty and Demolition - Bi-Metal

Part #	Blade Length	Teeth Per Inch	Pack Description	Width / Length	QTY.	List/Pack
HD610-B	6"	10/14T	Heavy Duty	3/4" x 6" x .050"	50	\$178.84
HD810-B	8"	10/14T	Heavy Duty	3/4" x 8" x .050"	50	\$243.04
HD120-B	12"	10/14T	Heavy Duty	3/4" x 12" x .050"	50	\$312.03
DM606-B	6"	6T	Demolition	7/8" x 6" x .062"	25	\$168.21
DM610-B	6"	10T	Demolition	7/8" x 6" x .062"	25	\$168.21
DM906-B	9"	6T	Demolition	7/8" x 9" x .062"	25	\$213.65
DM910-B	9"	10T	Demolition	7/8" x 9" x .062"	25	\$213.65
DM1206-B	12"	6T	Demolition	7/8" x 12" x .062"	25	\$283.27
DM1210-B	12"	10T	Demolition	7/8" x 12" x .062"	25	\$283.27

- ◆ Made In USA
- ◆ Same Bi-Metal Blades p. 59 & 61
- ◆ Slim-Line Retail Packs
- ◆ Price Per Pack







**Made In**



- ◆ Made In U.S.A.
- ◆ Industrial Quality
- ◆ Milled Teeth

### BOSCH Shank Metal Cutting Blades - Bi-Metal



Part #	Blade Length	Teeth Per Inch	Description	Width / Length	Application	Pack QTY.	List/ea.	Bulk (50 Pcs.) Part #	List/ea.
BJB30014M	3"	14T	Bosch Shank Jig Saw	3" x 3/8" x 0.35"	THICK METAL	5	\$2.78	BJB30014MB	\$2.71
BJB30018M	3"	18T	Bosch Shank Jig Saw	3" x 3/8" x 0.35"	METAL TUBING	5	\$2.78	BJB30018MB	\$2.71
BJB30024M	3"	24T	Bosch Shank Jig Saw	3" x 3/8" x 0.35"	THIN METAL TUBING	5	\$2.78	BJB30024MB	\$2.71
BJB52521M	5-1/4"	21T	Bosch Shank Jig Saw	5-1/4" x 5/16" x .042"	SOFT STEEL ALUMINUM	5	\$5.67	BJB52521MB	\$5.60

### BOSCH Shank Wood / Plastic Cutting Blades - Bi-Metal

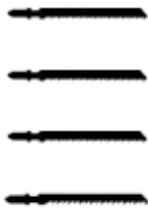

Part #	Blade Length	Teeth Per Inch	Description	Width / Length	Application	Pack QTY.	List/ea.	Bulk (50 Pcs.) Part #	List/ea.
BJB40006W	4"	6T	Bosch Shank Jig Saw	4" x 5/16" x .040"	WOOD FIBER BOARD	5	\$3.38	BJB40006WB	\$3.32
BJB40008W	4"	8T	Bosch Shank Jig Saw	4" x 5/16" x .035"	GENERAL WOOD/PLASTIC	5	\$3.38	BJB40008WB	\$3.32
BJB40010W	4"	10T	Bosch Shank Jig Saw	4" x 5/16" x .035"	ALL WOOD/PLASTIC	5	\$3.38	BJB40010WB	\$3.32
BJB52512W	5-1/4"	12T	Bosch Shank Jig Saw	5-1/4" x 5/16" x .042"	WOOD/PLASTIC METAL	5	\$5.67	BJB52512WB	\$5.60

### UNIVERSAL Shank Metal Cutting Blades - Bi-Metal



Part #	Blade Length	Teeth Per Inch	Description	Width / Length	Application	Pack QTY.	List/ea.	Bulk (50 Pcs.) Part #	List/ea.
UJB23418M	2-3/4"	18T	Universal Shank Jig Saw Blade	2-3/4" x 3/16" x .035"	SCROLL METAL	5	\$2.44	UJB23418MB	\$2.37
UJB30018M	3"	18T	Universal Shank Jig Saw Blade	3" x 3/8" x .035"	METAL 18 GAUGE & UNDER	5	\$2.31	UJB30018MB	\$2.24
UJB30024M	3"	24T	Universal Shank Jig Saw Blade	3" x 3/8" x .035"	METAL 18 GAUGE & UNDER	5	\$2.31	UJB30024MB	\$2.24
UJB40014M	4"	14T	Universal Shank Jig Saw Blade	4" x 3/8" x .035"	WOOD, RUBBER METAL UP TO 1/8"	5	\$2.61	UJB40014MB	\$2.54

### UNIVERSAL Shank Wood Cutting Blades - Bi-Metal



Part #	Blade Length	Teeth Per Inch	Description	Width / Length	Application	Pack QTY.	List/ea.	Bulk (50 Pcs.) Part #	List/ea.
UJB40006W	4"	6T	Universal Shank Jig Saw Blade	4" x 3/8" x .035"	HARD WOOD BOARD	5	\$2.61	UJB40006WB	\$2.54
UJB40010W	4"	10T	Universal Shank Jig Saw Blade	4" x 3/8" x .035"	HARD WOOD BOARD	5	\$2.61	UJB40010WB	\$2.54



This High Tension Hack Saw Frame features a **NEW Cushin' Grip** handle and end pieces made of die cast aluminum. It is light weight yet extremely rigid and high tensioned; which provides cleaner, surer cuts. The blade can be set at a 55° angle for special flush cutting jobs (see figure A). The blade can also be inserted into the front end of the hack saw frame, and used as a versatile compass saw (see figure B). This frame fits most standard tool boxes.

- ◆ RED Cast Aluminum
- ◆ Light Weight
- ◆ Extremely Rigid
- ◆ Versatile
- ◆ 25,000 lbs Per Square Inch
- ◆ Includes 1 12" x 24T Bi-Metal Blade

## High Tension Hack Saw Frame

Part #	Description	List
278HX0002	High Tension Hack Saw Frame	\$26.05



## Hack Saw Blades - Bi-Metal

Part #	OAL	Teeth Per Inch	Wide	Thick	QTY.	List/ea.
278BM0018	12"	18T	1/2"	.025"	10	\$2.20
278BM0024	12"	24T	1/2"	.025"	10	\$2.20
278BM0032	12"	32T	1/2"	.025"	10	\$2.20

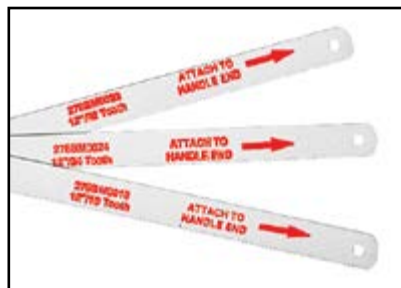

- ◆ Bi-Metal
- ◆ 8% Cobalt
- ◆ Premium Quality
- ◆ White Finish

## Band Saw Blades - Bi-Metal

Part #	OAL	Teeth Per Inch	Wide	Thick	QTY.	List/ea.
279SB0010	44-7/8"	10T	1/2"	.020"	3	\$11.50
279SB0014	44-7/8"	14T	1/2"	.020"	3	\$11.50
279SB0018	44-7/8"	18T	1/2"	.020"	3	\$11.50
279SB0024	44-7/8"	24T	1/2"	.020"	3	\$11.50
279VP1014	44-7/8"	10/14	1/2"	.020"	3	\$11.50
279VP1418	44-7/8"	14/18	1/2"	.020"	3	\$11.50



### Made In



- ◆ Made In USA
- ◆ Bi-Metal
- ◆ 8% Cobalt
- ◆ Premium Quality
- ◆ Standard or Variable Pitch
- ◆ Use In All Hand Held Band Saws



Made In



- ◆ Heavy Duty
- ◆ Red Oxide Finish

## Reciprocating Blade Rack

Part #	Rack	List
RACK10	Recip Rack	\$58.13

**RACK10**

3"Out X 8"H X 12"W

1/8" Metal Wire



Retail Packs  
P. 62



**RACK12**

7"Out X 8"H X 24"W

1/4" Metal Wire

Made In



- ◆ Heavy Duty
- ◆ Black Oxide Finish

## Metal Display Racks

Part #	Rack	List
RACK12	Top Header	\$81.38
RACK18	Bottom X-Tra	\$102.26

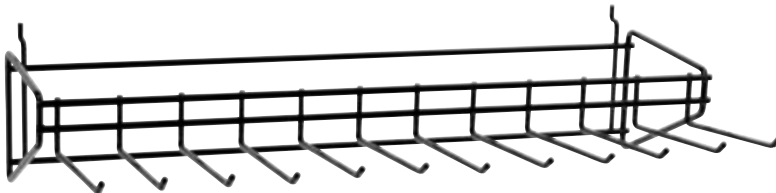

**RACK18**

15"Out X 8"H X 24"W

1/4" Metal Wire

All individually packed **ITM** drill bits have barcode and can be hung on this display. Simple and hassle free.



P. 91

P. 21

P. 88

P. 81

P. 82

P. 87

P. 50

## Electrician's Flex Bit With Screw Point - Stretch Bit

Part #	Size	X	OAL	Shank	Application	List
308FB2438	3/8"	X	24"	3/16"	Popular with alarm & communication installers for pulling light wire.	\$38.63
308FB3638	3/8"	X	36"	3/16"		\$40.66
308FB5438	3/8"	X	54"	3/16"		\$45.18
308FB7238	3/8"	X	72"	3/16"		\$50.32
308FB2412	1/2"	X	24"	3/16"	Popular with alarm & communication installers for pulling light wire.	\$43.82
308FB3612	1/2"	X	36"	3/16"		\$47.95
308FB5412	1/2"	X	54"	3/16"		\$48.69
308FB7212	1/2"	X	72"	3/16"		\$53.27

- ◆ Screw Point
- ◆ Self Drilling
- ◆ Fish Hole On Each End
- ◆ Flexible Shaft

- Wood
- Studs
- Insulation



FISH HOLE ON SHANK



Stretch Bits are constructed of a high carbon steel self-feed auger bit, permanently brazed to a flexible shaft. This tool can be inserted through small wall openings enabling the operator to bore holes through studs within the wall cavities without damaging finished walls or ceilings.

Eye Holes are provided at each end of the Stretch Bits which allow easy retrieval of wires from either direction after drilling.

## Steering Guide

Part #	Description	Application	List
308FBG	Steering Guide	Helps manipulate bits while within the wall cavity.	\$45.00



## Circular Saw Blades

Part #	Size	List
DS-58-724	7-1/4" X 24T	\$12.49
CS-58-824	8-1/4" X 24T	\$23.28
CS-58-840	8-1/4" X 40T	\$34.73

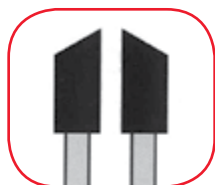

ALTERNATE TOP BEVELED TEETH

- ◆ Hard Body 38-42 Rc.
- ◆ K20 Tungsten Carbide Grade
- ◆ Individually Protected
- ◆ Individually Barcoded
- ◆ Imported

- ◆ Tungsten Carbide Tipped
- ◆ 5/8" Arbor With Diamond Knock Out
- ◆ 7000 RPM Maximum

- Wood Only



**HSS Bell Hanger - Feeler Bits With Fish Hole (Electrical / Wire)**

- ◆ Fish Hole In Flute For Pulling Wire
- ◆ Special Point For Fast Drilling In Wood & Metal
- ◆ Tapering For Quick Chip Clearance
- Telephone Installation
- Burglar Alarms
- Wire & Cable Applications

Part #	Size	OAL	Shank	Qty.	List	Part #	Size	OAL	Shank	Qty.	List
308BH1200	3/16"	12"	3/16"	1	\$10.80	308BH2403	3/8"	24"	3/8"	1	\$19.24
308BH1800	3/16"	18"	3/16"	1	\$11.50	308BH3003	3/8"	30"	3/8"	1	\$21.32
308BH1201	1/4"	12"	1/4"	1	\$11.34	308BH4203	3/8"	42"	3/8"	1	\$44.19
308BH1801	1/4"	18"	1/4"	1	\$12.50	308BH4803	3/8"	48"	3/8"	1	\$54.36
308BH2401	1/4"	24"	1/4"	1	\$15.60	308BH1806	7/16"	18"	3/8"	1	\$25.50
308BH3001	1/4"	30"	1/4"	1	\$18.93	308BH1204	1/2"	12"	3/8"	1	\$15.22
308BH4201	1/4"	42"	1/4"	1	\$38.86	308BH1804	1/2"	18"	3/8"	1	\$17.76
308BH1202	5/16"	12"	5/16"	1	\$12.55	308BH2404	1/2"	24"	3/8"	1	\$25.12
308BH1802	5/16"	18"	5/16"	1	\$14.05	308BH3004	1/2"	30"	3/8"	1	\$26.90
308BH2402	5/16"	24"	5/16"	1	\$18.68	308BH4204	1/2"	42"	3/8"	1	\$53.40
308BH1203	3/8"	12"	3/8"	1	\$13.42	308BH4804	1/2"	48"	3/8"	1	\$61.31
308BH1803	3/8"	18"	3/8"	1	\$15.31	308BH1858	5/8"	18"	1/2"	1	\$22.85
						308BH1805	3/4"	18"	1/2"	1	\$24.90
						308BH1810	1"	18"	1/2"	1	\$31.25



ALL BELL HANGER DRILL BITS ARE SOLD INDIVIDUALLY

**CARBON STEEL Bell Hanger - Feeler Bits With Fish Hole**

Part #	Size	OAL	Shank	Qty.	List	Part #	Size	OAL	Shank	Qty.	List
308CS1412	1/4"	12"	1/4"	1	\$5.45	308CS3818	3/8"	18"	3/8"	1	\$7.88
308CS1418	1/4"	18"	1/4"	1	\$6.42	308CS3824	3/8"	24"	3/8"	1	\$11.32
308CS1424	1/4"	24"	1/4"	1	\$9.05	308CS1804	1/2"	18"	3/8"	1	\$14.61

Less expensive than High Speed Steel (HSS) - Carbon Steel drills all wood, studs, aluminum, insulation, and drywall. Will not perform as well as HSS in steel.



**Carbide Tip Bell Hanger - Feeler Bits With Fish Hole (Electrical / Wire)**

- ◆ Fish Hole In Flute For Pulling Wire
- ◆ Special Point For Fast Drilling In Masonry & Wood
- Telephone Installation
- Burglar Alarms
- Wire & Cable Applications

Part #	Size	OAL	Shank	Qty.	List	Part #	Size	OAL	Shank	Qty.	List
308CT1301	1/4"	13"	1/4"	1	\$11.94	308CT1304	1/2"	13"	3/8"	1	\$14.06
308CT1801	1/4"	18"	1/4"	1	\$13.01	308CT1804	1/2"	18"	3/8"	1	\$17.82
308CT2401	1/4"	24"	1/4"	1	\$15.31	308CT2404	1/2"	24"	3/8"	1	\$18.86
308CT1302	5/16"	13"	5/16"	1	\$12.87	308CT3004	1/2"	30"	3/8"	1	\$22.14
308CT1802	5/16"	18"	5/16"	1	\$14.31	308CT1305	3/4"	13"	1/2"	1	\$26.95
308CT2402	5/16"	24"	5/16"	1	\$15.31	308CT1805	3/4"	18"	1/2"	1	\$38.61
308CT1303	3/8"	13"	3/8"	1	\$13.33						
308CT1803	3/8"	18"	3/8"	1	\$15.01						
308CT2403	3/8"	24"	3/8"	1	\$16.19						
308CT3003	3/8"	30"	3/8"	1	\$18.45						
308CT3638	3/8"	36"	3/8"	1	\$22.38						

## 12" Long Boy - HSS

Part #	Size	Dec.	OAL	Flute	Qty.	List
216HS0864	1/8"	.1250	12"	9"	1	\$12.37
216HS1264	3/16"	.1875	12"	9"	1	\$12.72
216HS1464	7/32"	.2188	12"	9"	1	\$16.20
216HS1664	1/4"	.2500	12"	9"	1	\$14.98
216HS1864	9/32"	.2812	12"	9"	1	\$17.33
216HS2064	5/16"	.3125	12"	9"	1	\$21.47
216HS2464	3/8"	.3750	12"	9"	1	\$24.76
216HS2864	7/16"	.4375	12"	9"	1	\$46.46
216HS3264	1/2"	.5000	12"	9"	1	\$46.87
216HS3664	9/16"	.5625	12"	9"	1	\$74.00
216HS4064	5/8"	.6250	12"	9"	1	\$86.04
216HS4464	11/16"	.6875	12"	9"	1	\$110.94
216HS4864	3/4"	.7500	12"	9"	1	\$122.97
216HS5264	13/16"	.8125	12"	9"	1	\$139.76
216HS5664	7/8"	.8750	12"	9"	1	\$159.60
216HS6064	15/16"	.9375	12"	9"	1	\$178.49
216HS6464	1"	1.000	12"	9"	1	\$192.06
216HS7264	1-1/8"	1.1250	12"	9"	1	\$262.62

## 18" Long Boy - HSS

Part #	Size	Dec.	OAL	Flute	Qty.	List
217HS1664	1/4"	.2500	18"	14"	1	\$27.29
217HS2064	5/16"	.3125	18"	14"	1	\$39.43
217HS2464	3/8"	.3750	18"	14"	1	\$54.49
217HS3064	15/32"	.4688	18"	14"	1	\$77.83
217HS3264	1/2"	.5000	18"	14"	1	\$91.38
217HS4064	5/8"	.6250	18"	14"	1	\$121.36
217HS4864	3/4"	.7500	18"	14"	1	\$150.88



## Brad Point Wood Drill

Part #	Size	OAL	Shank	Qty.	List
309BP0864	1/8"	2-1/2"	1/8"	1	\$2.33
309BP1064	5/32"	3-1/8"	5/32"	1	\$2.78
309BP1264	3/16"	3-3/8"	3/16"	1	\$3.17
309BP1664	1/4"	4"	1/4"	1	\$3.63
309BP2064	5/16"	4-5/8"	5/16"	1	\$3.89
309BP2464	3/8"	4-7/8"	3/8"	1	\$4.34
309BP2864	7/16"	5-1/2"	3/8"	1	\$6.09
309BP3264	1/2"	6"	3/8"	1	\$7.38
309BP4064	5/8"	7"	3/8"	1	\$10.79
309BP4864	3/4"	7-3/4"	3/8"	1	\$28.17
309BP5664	7/8"	8-1/8"	3/8"	1	\$37.12
309BP6464	1"	8-1/2"	3/8"	1	\$48.24



**118°  
POINT**

- ◆ M2 HSS
- ◆ Straight Shank To 1/2", Then Reduced
- ◆ Sharp Cutting Edge To Drill In Many Different Materials

- Mild Steel
- Aluminum
- Cast Iron
- Wood

- ⊙ Precision point angle for effective penetration through steel and wood.
- ⊙ Extra length flute with continuous cutting edges for drilling deep holes and fast chip removal.
- ⊙ Reduced shank fits all drill motors with 1/2" chucks.
- ⊙ Non-slip grips prevent the bit from spinning in the chuck.



**Great For  
Acrylics!**

- ◆ Precision Ground Flute
- ◆ Center Spur
- ◆ Two Shoulder Cutting Spurs
- ◆ Industrial Quality

- Wood
- Acrylics
- Polycarbonates



**Part # 309BP0007**  
**7 Pc. Set Woodworking**  
 1/8" - 3/16" - 1/4" - 5/16" - 3/8" -  
 7/16" - 1/2"  
**List Price Each \$50.01**



ALL SPADE POINT POWER DRILL BITS ARE SOLD INDIVIDUALLY. 1 PER POUCH.



**Part # 300-ST-06**

6 Pc. Spade Bit Set  
3/8" - 1/2" - 5/8"  
3/4" - 7/8" - 1"

List Price  
Each \$21.26



- ◆ Cold Forged
- ◆ Full Length Treated
- ◆ Machine Finish
- ◆ Cutting Groove
- ◆ Rust Protection
- ◆ Wing Tip Design
- ◆ 1/4" Hex Power Groove Shank
- ◆ Individually Stamped With Size
- ◆ Industrial Quality

- Wood
- Drywall
- Plywood



**IMPACT**  
1/4" HEX IMPACT SHANK

Quick Insert / Quick Spring Out Chuck Extensions. SOLD INDIVIDUALLY.



**IMPACT**  
1/4" HEX IMPACT SHANK

- ◆ Quick-Change
- ◆ 1 PC. Construction
- ◆ 1/4" Hex Power Groove Shank
- ◆ Industrial Quality

**6" Long Spade Wood Drill**

Part #	Size	OAL	Qty.	List
300SB1664	1/4"	6"	1	\$3.44
300SB2064	5/16"	6"	1	\$3.44
300SB2464	3/8"	6"	1	\$3.44
300SB2864	7/16"	6"	1	\$3.44
300SB3264	1/2"	6"	1	\$3.44
300SB3664	9/16"	6"	1	\$4.09
300SB4064	5/8"	6"	1	\$4.09
300SB4464	11/16"	6"	1	\$4.09
300SB4864	3/4"	6"	1	\$4.09
300SB5264	13/16"	6"	1	\$4.09
300SB5664	7/8"	6"	1	\$4.25
300SB6064	15/16"	6"	1	\$4.25
300SB6464	1"	6"	1	\$4.25
300SB7264	1-1/8"	6"	1	\$6.16
300SB8064	1-1/4"	6"	1	\$6.16
300SB8864	1-3/8"	6"	1	\$6.16
300SB9664	1-1/2"	6"	1	\$6.16

**16" Long Spade Wood Drill**

Part #	Size	OAL	Qty.	List
301SB1664	1/4"	16"	1	\$8.93
301SB2464	3/8"	16"	1	\$8.93
301SB3264	1/2"	16"	1	\$8.93
301SB4064	5/8"	16"	1	\$9.29
301SB4864	3/4"	16"	1	\$9.29
301SB5664	7/8"	16"	1	\$10.70
301SB6464	1"	16"	1	\$11.76
301SB8864	1-3/8"	16"	1	\$13.34



**Extension - For Spade Bit**

Part #	Size	For Shank	Ø	List
EXT-300	1/4" x 12"	1/4"	5/8"	\$14.18
EXT-500	1/4" x 18"	1/4"	5/8"	\$16.28

1/4" Extensions - Drill Diameter Must Be Larger Than 5/8".



## Self Feed (Multispur) Wood Drill

Part #	Size	MM	Pipe Entrance	Tubing Entrance	Cutting Flute	Shank	List
306ST-1	1"	25.4	1/2"	7/8"	1"	7/16"	\$40.25
306ST-2	1-1/8"	28.6	1/2"	1"	1"	7/16"	\$40.25
306ST-3	1-1/4"	31.8	3/4"	1-1/8"	1"	7/16"	\$40.25
306ST-4	1-3/8"	34.9	1"	1-1/4"	1"	7/16"	\$40.25
306ST-5	1-1/2"	38.1	1"	1-3/8"	1"	7/16"	\$40.25
306ST-6	1-3/4"	44.5	1-1/4"	1-1/2"	1"	7/16"	\$43.19
306ST-7	2"	50.8	1-1/2"	1-7/8"	1"	7/16"	\$46.14
306ST-8	2-1/8"	54.0	1-1/2"	2"	1"	7/16"	\$47.19
306ST-9	2-1/4"	57.2	1-1/2"	2-1/8"	1"	7/16"	\$51.19
306ST-10	2-9/16"	65.1	2"	2-1/2"	1"	7/16"	\$51.58
306ST-11	3"	76.2	2-1/2"	2-7/8"	2"	7/16"	\$132.94
306ST-12	3-5/8"	92.1	3"	3-1/2"	2"	7/16"	\$180.78
306ST-13	4-5/8"	117.5	4"	4-1/2"	2"	7/16"	\$212.75



- ◆ Fast Continuous and Self Feeding
- ◆ Deep Holes
- ◆ 7/16" Impact Hex Shank
- ◆ Double End Screw
- ◆ Extra Screw & Wrench
- ◆ Industrial Quality

- Wood
- Drywall
- Plywood
- Plumbing
- Rough-in Work

SELF FEED WOOD DRILLS ARE SOLD INDIVIDUALLY. 1 PER TUBE.



## Replacement Screw Points

Part #	Size	Fits	List
SP0001	1/4"	1-1/4" to 2-9/16"	\$6.75
SP0002	1/4"	3" to 4-5/8"	\$10.13

Screw Points come with replacement set screw and wrench.



## Extensions for Ship Auger & Multispur

### POWER BIT EXTENSIONS

Part #	Size	For Shank	Ø	List	Part #	Size	For Shank	Ø	List
307BT5618	5/16" x 18"	5/16"	11/16"	\$24.79	307BT7609	7/16" x 9-1/2"	7/16"	7/8"	\$26.03
					307BT7612	7/16" x 12"	7/16"	7/8"	\$26.03
					307BT7618	7/16" x 18"	7/16"	7/8"	\$30.17
					307BT7624	7/16" x 24"	7/16"	7/8"	\$37.74

- ◆ HEX Wrench Included
- ◆ 2 Set Screws

5/16" Extensions - Drill Diameter Must Be Larger Than 11/16".  
7/16" Extensions - Drill Diameter Must Be Larger Than 7/8".





- ◆ Carbide Tipped
- ◆ Hex Shank
- ◆ Heat Treated
- ◆ Machine Ground
- ◆ Hollows
- ◆ Deep Throat
- ◆ Single Twist
- ◆ Single Cutter
- ◆ Side Lip
- ◆ Power Groove
- ◆ Self-Feeding Screw Point
  
- CCA Poles
- Creosoted Poles
- Railroad Ties
- Bulk Heads
- Heavy Timber

Made in Europe

ALL POWER POLE AUGER DRILL BITS ARE SOLD INDIVIDUALLY.

## Power Pole Auger Wood Drills

Part #	Size	OAL	Drilling	Shank	List
CPP-11121	1/2"	18"	15"	7/16"	\$143.75
CPP-12122	1/2"	24"	21"	7/16"	\$168.26
CPP-13123	1/2"	36"	33"	7/16"	\$179.00
CPP-14911	9/16"	18"	15"	7/16"	\$183.33
CPP-15912	9/16"	24"	21"	7/16"	\$180.69
CPP-16913	9/16"	36"	33"	7/16"	\$214.45
CPP-17581	5/8"	18"	15"	7/16"	\$148.77
CPP-18582	5/8"	24"	21"	7/16"	\$160.67
CPP-19583	5/8"	36"	33"	7/16"	\$192.81
CPP-20161	11/16"	18"	15"	7/16"	\$151.05
CPP-21162	11/16"	24"	21"	7/16"	\$176.13
CPP-22163	11/16"	36"	33"	7/16"	\$218.50
CPP-23241	3/4"	18"	15"	7/16"	\$175.50
CPP-24342	3/4"	24"	21"	7/16"	\$185.14
CPP-25343	3/4"	36"	33"	7/16"	\$228.25
CPP-26131	13/16"	18"	15"	7/16"	\$187.50
CPP-27132	13/16"	24"	21"	7/16"	\$198.02
CPP-28133	13/16"	36"	33"	7/16"	\$231.04
CPP-28648	13/16"	48"	45"	7/16"	\$302.73
CPP-29781	7/8"	18"	15"	7/16"	\$160.28
CPP-30782	7/8"	24"	21"	7/16"	\$198.02
CPP-31783	7/8"	36"	33"	7/16"	\$231.04
CPP-32561	15/16"	18"	15"	7/16"	\$192.78
CPP-33562	15/16"	24"	21"	7/16"	\$205.09
CPP-34563	15/16"	36"	33"	7/16"	\$239.27
CPP-34648	15/16"	48"	45"	7/16"	\$317.05
CPP-35115	1"	18"	15"	7/16"	\$196.64
CPP-36121	1"	24"	21"	7/16"	\$209.19
CPP-37133	1"	36"	33"	7/16"	\$244.06
CPP-38135	1-1/16"	24"	21"	7/16"	\$194.43
CPP-39136	1-1/16"	36"	33"	7/16"	\$225.85
CPP-40137	1-1/16"	48"	45"	7/16"	\$331.23

**Use with 1/2" Drills or Impact Wrenches:**

- Stanley ID-04 "Yellow Jacket"
- Racine HIW-716
- Fairmount H8508

**Also works well in heavy duty electric, pneumatic, and gas powered drills.**



Power Pole Auger Drill Bits are carbide tipped wood drill bits that have a carbide-tipped cutting tip combined with a hardened steel cutting edge. These unique carbide tipped wood drill bits bore holes in all types of wood quickly, leaving little or no residue. A truly clean, smooth hole is produced. Power Pole carbide tipped wood auger drill bits require less torque to operate and can be used with electric, air, or gasoline powered drill motors and impact wrenches.

**Made of premium steel, Power Pole Auger Bits are for boring CCA and Creosoted poles, railroad ties, bulkheads, and other heavy timber.**



### 8" Long Ship Auger Wood Drill

Part #	Size	Size In 16ths	OAL	Hex Shank	List
302SL3264	1/2"	8	8"	5/16"	\$27.82
302SL3664	9/16"	9	8"	5/16"	\$27.82
302SL4064	5/8"	10	8"	5/16"	\$27.82
302SL4464	11/16"	11	8"	5/16"	\$28.66
302SL4864	3/4"	12	8"	5/16"	\$29.53
302SL5264	13/16"	13	8"	5/16"	\$34.41
302SL5664	7/8"	14	8"	7/16"	\$35.55
302SL6064	15/16"	15	8"	7/16"	\$43.06
302SL6464	1"	16	8"	7/16"	\$43.95
302SL7264	1-1/8"	18	8"	7/16"	\$48.90
302SL8064	1-1/4"	20	8"	7/16"	\$56.65
302SL8864	1-3/8"	22	8"	7/16"	\$71.24
302SL9664	1-1/2"	24	8"	7/16"	\$73.90

- ◆ 6" Twist Length
- ◆ Heat Treated
- ◆ Machine Ground Hollows
- ◆ Deep Throat
- ◆ Single Twist
- ◆ Single Cutter
- ◆ Side Lip
- ◆ Self-Feeding Screw Point



- ➔ Bulk Heads
- ➔ General Timber

ALL SHIP AUGER DRILL BITS ARE SOLD INDIVIDUALLY.



### 18" Long Ship Auger Wood Drill

Part #	Size	Size In 16ths	OAL	Hex Shank	List
303SL2464	3/8"	6	18"	5/16"	\$34.20
303SL2864	7/16"	7	18"	5/16"	\$34.20
303SL3264	1/2"	8	18"	5/16"	\$34.20
303SL3664	9/16"	9	18"	7/16"	\$34.20
303SL4064	5/8"	10	18"	7/16"	\$34.20
303SL4464	11/16"	11	18"	7/16"	\$37.57
303SL4864	3/4"	12	18"	7/16"	\$37.59
303SL5264	13/16"	13	18"	7/16"	\$41.76
303SL5664	7/8"	14	18"	7/16"	\$43.72
303SL6064	15/16"	15	18"	7/16"	\$47.81
303SL6464	1"	16	18"	7/16"	\$48.58
303SL7264	1-1/8"	18	18"	7/16"	\$57.46
303SL8064	1-1/4"	20	18"	7/16"	\$66.91
303SL8864	1-3/8"	22	18"	7/16"	\$74.54
303SL9664	1-1/2"	24	18"	7/16"	\$78.90

- ◆ 15" Twist Length
- ◆ Heat Treated
- ◆ Machine Ground Hollows
- ◆ Deep Throat
- ◆ Single Twist
- ◆ Single Cutter
- ◆ Side Lip
- ◆ Self-Feeding Screw Point



- ➔ Bulk Heads
- ➔ General Timber

ALL SHIP AUGER DRILL BITS ARE SOLD INDIVIDUALLY.



### 7" Sharpening File - Ship Augers

Part #	Description	List
303SL-F1	7" Sharpening File	\$23.65

Files are specially designed to sharpen your valuable auger bits for a longer cutting life. These files feature one end single cut with safe edges (uncut) and one end safe (uncut) with single cut edges.

Made Of Premium Steel, Ship Auger Drills Are For Boring Bulkheads And General Timber.



## Single Spur - Double Twist Wood Drill

- ◆ 8-1/2" Length
- ◆ 5-1/2" Twist Length
- ◆ Heat Treated
- ◆ Machine Ground Hollows
- ◆ Self-Feeding Screw Point
- ◆ Impact Hex Shank

### ELECTRICIAN'S POWER BITS

**These power bits are specifically designed to fit in between building studs for the installation of conduits and wires. Ideal use is with angle power drills.**

**Packaged with a rust protection sleeve. Sold Individually.**

Part #	Size	OAL	Shank	List
304BU4064	5/8"	8-1/2"	5/16"	\$35.29
304BU4464	11/16"	8-1/2"	5/16"	\$37.57
304BU4864	3/4"	8-1/2"	5/16"	\$39.17
304BU5264	13/16"	8-1/2"	5/16"	\$43.82
304BU5664	7/8"	8-1/2"	5/16"	\$45.39
304BU6464	1"	8-1/2"	5/16"	\$54.01
304BU7264	1-1/8"	8-1/2"	7/16"	\$58.18
304BU8064	1-1/4"	8-1/2"	7/16"	\$65.95



## Double Spur - Double Twist Wood Drill

- ◆ 6-1/2" Length
- ◆ 4" Twist Length
- ◆ Heat Treated
- ◆ Machine Ground Hollows
- ◆ Self-Feeding Screw Point
- ◆ Impact Hex Shank

### PLUMBER POWER BITS

**These power bits are specifically designed for boring holes where a smooth finish is required. Ideal for plumbing, heating, air conditioning, and other pipe installation.**

**Packaged with a rust protection sleeve. Sold Individually.**

Part #	Size	OAL	Shank	List
305BU4864	3/4"	6-1/2"	7/16"	\$36.06
305BU5664	7/8"	6-1/2"	7/16"	\$43.08
305BU6464	1"	6-1/2"	7/16"	\$54.81
305BU7264	1-1/8"	6-1/2"	7/16"	\$58.22
305BU8064	1-1/4"	6-1/2"	7/16"	\$62.11
305BU8864	1-3/8"	6-1/2"	7/16"	\$80.89
305BU9664	1-1/2"	6-1/2"	7/16"	\$99.83



**OSCILLATING MULTI-TOOL**



**Oscillating Blades - Wood / Metal**

Part #	Use For	Shank	Teeth	TPI	Width	Length	Box Qty.	List/ea.
M-J35-10	<b>PRECISE WOOD</b>	Multi	Japanese	15	1-3/8"	2-1/32"	10	\$15.69
M-J35-25	<b>PRECISE WOOD</b>	Multi	Japanese	15	1-3/8"	2-1/32"	25	\$14.94
M-J35-100	<b>PRECISE WOOD</b>	Multi	Japanese	15	1-3/8"	2-1/32"	100	\$14.23
O-J35-10	<b>PRECISE WOOD</b>	Open	Japanese	15	1-3/8"	2-1/32"	10	\$15.69
O-J35-25	<b>PRECISE WOOD</b>	Open	Japanese	15	1-3/8"	2-1/32"	25	\$14.94
O-J35-100	<b>PRECISE WOOD</b>	Open	Japanese	15	1-3/8"	2-1/32"	100	\$14.23
O-M43-10	<b>METAL</b>	Open	Bi-Metal	18	1-11/16"	2-1/2"	10	\$21.26
O-M43-25	<b>METAL</b>	Open	Bi-Metal	18	1-11/16"	2-1/2"	25	\$20.25
O-M43-100	<b>METAL</b>	Open	Bi-Metal	18	1-11/16"	2-1/2"	100	\$19.28
O-S42-10	<b>WOOD AND NAIL</b>	Open	Bi-Metal	16	1-9/16"	3-1/32"	10	\$21.06
O-S42-25	<b>WOOD AND NAIL</b>	Open	Bi-Metal	16	1-9/16"	3-1/32"	25	\$20.06
O-S42-100	<b>WOOD AND NAIL</b>	Open	Bi-Metal	16	1-9/16"	3-1/32"	100	\$19.10
Q-J35-10	<b>PRECISE WOOD</b>	Quick Fit	Japanese	15	1-3/8"	2-1/32"	10	\$18.07
Q-J35-25	<b>PRECISE WOOD</b>	Quick Fit	Japanese	15	1-3/8"	2-1/32"	25	\$17.21
Q-J35-100	<b>PRECISE WOOD</b>	Quick Fit	Japanese	15	1-3/8"	2-1/32"	100	\$16.39
Q-M43-10	<b>METAL</b>	Quick Fit	Bi-Metal	18	1-11/16"	2-1/2"	10	\$24.44
Q-M43-25	<b>METAL</b>	Quick Fit	Bi-Metal	18	1-11/16"	2-1/2"	25	\$23.28
Q-M43-100	<b>METAL</b>	Quick Fit	Bi-Metal	18	1-11/16"	2-1/2"	100	\$22.17
Q-S42-10	<b>WOOD AND NAIL</b>	Quick Fit	Bi-Metal	16	1-9/16"	3-1/32"	10	\$26.21
Q-S42-25	<b>WOOD AND NAIL</b>	Quick Fit	Bi-Metal	16	1-9/16"	3-1/32"	25	\$24.96
Q-S42-100	<b>WOOD AND NAIL</b>	Quick Fit	Bi-Metal	16	1-9/16"	3-1/32"	100	\$23.78



**PRECISE WOOD**  
 → Wood  
 → Drywall  
 → Plywood

**METAL**  
 → Nails → Aluminum  
 → Metal → Copper  
 → PVC → Drywall  
 → Wood → Plywood

**WOOD AND NAIL**  
 → Metal  
 → Wood  
 → Nails

- ◆ Use With Oscillating Multi-Tool
- ◆ Stainless Steel Attachment
- ◆ Deepest Plunge Depth
- ◆ Made in Switzerland



**Drywall Cutter - HSS**

Part #	Size	OAL	Qty.	List
DW-316	3/16"	3-1/4"	1	\$20.69



- ◆ Use With Rotary Tool
- ◆ M2 HSS
- Drywall
- Electrical Boxes
- Air Vents



**ROTARY CUTOUT TOOL**



**ROTATION ONLY**  
Fast drilling speeds and lubricant are recommended when using these drills.



**V GROOVE Tile Bit**

Part #	Size	X	OAL	Drilling	Shank	Qty.	List
VG-4001	1/8"	X	3"	2"	1/8"	1	\$7.53
VG-3002	3/16"	X	3"	2-3/4"	3/16"	1	\$7.53
VG-3002B	3/16"	X	3"	2-3/4"	3/16"	25	\$188.25
VG-4002	3/16"	X	4"	2-3/4"	3/16"	1	\$8.85
VG-4002B	3/16"	X	4"	2-3/4"	3/16"	25	\$221.25
VG-6001	3/16"	X	6"	4-1/4"	3/16"	1	\$9.24
VG-6001B	3/16"	X	6"	4-1/4"	3/16"	25	\$231.00
VG-4003	1/4"	X	4"	2-3/4"	1/4"	1	\$8.90
VG-4003B	1/4"	X	4"	2-3/4"	1/4"	25	\$222.50
VG-6002	1/4"	X	6"	4-1/4"	1/4"	1	\$11.33
VG-6002B	1/4"	X	6"	4-1/4"	1/4"	25	\$283.25
VG-6003	5/16"	X	6"	4-1/4"	5/16"	1	\$14.49
VG-6003B	5/16"	X	6"	4-1/4"	5/16"	25	\$362.25
VG-6004	3/8"	X	6"	4-1/4"	3/8"	1	\$18.91
VG-6005	1/2"	X	6"	4-1/4"	1/2"	1	\$22.70

- ◆ Precision Design
- ◆ Special Carbide Head
- ◆ Carbide Insert Cuts

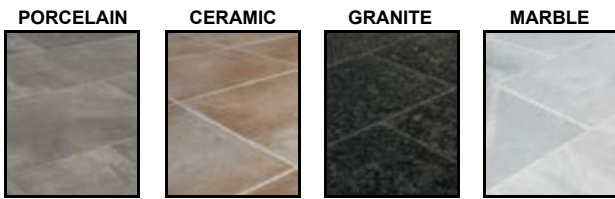

**Blu Diamond Tile Bit**

Part #	Size	OAL	Shank	List
BLU-1	1/4"	2"	3/8"	\$33.45
BLU-3	5/16"	2"	3/8"	\$33.85
BLU-4	3/8"	2-1/2"	3/8"	\$34.60
BLU-5	1/2"	2-1/2"	3/8"	\$43.36
BLU-6	3/4"	2-3/4"	3/8"	\$45.56
BLU-8	1"	2-3/4"	3/8"	\$48.55

- ◆ Diamond Segments
- ◆ Wet Drilling
- ◆ Core Extraction
- ◆ Rotation Only

- Porcelain
- Ceramic
- Granite
- Marble



**Glass Drills - STANDARD TIP**

Part #	Size	OAL	Shank	List
601GL0864	1/8"	2-1/4"	1/8"	\$7.41
601GL1264	3/16"	2-3/4"	3/16"	\$8.54
601GL1664	1/4"	3"	1/4"	\$9.05
601GL2064	5/16"	3-1/4"	1/4"	\$10.05
601GL2464	3/8"	3-1/2"	3/8"	\$14.13
601GL3264	1/2"	4"	3/8"	\$20.10

**ROTATION ONLY**  
Fast drilling speeds and lubricant are recommended when using these drills.



**Glass Drills - QUAD-CUTTER**

Part #	Size	OAL	Shank	List
QG-0012	3/16"	2-3/4"	3/16"	\$9.03
QG-0014	1/4"	3"	1/4"	\$11.00
QG-0016	5/16"	3-1/4"	1/4"	\$13.26
QG-0018	3/8"	3-1/2"	3/8"	\$16.58
QG-0020	1/2"	4"	3/8"	\$23.87

- ◆ Tungsten Carbide Tip

- Glass
- Mirrors
- Ceramics
- Tile
- Acrylics



**Glass Drills - RAZOR CUTTER**

Part #	Size	OAL	Shank	List
RAZ-4002	3/16"	4"	3/16"	\$9.33
RAZ-4003	1/4"	4"	1/4"	\$10.11





**ROTATION ONLY**  
Moderate drilling speeds and lubricant are recommended when using these drills.



### Multi Purpose Drills - CARBIDE TIP

Part #	Size	OAL	Drilling	Shank	List
600CD0864	1/8"	3"	1-1/2"	1/8"	\$5.95
600CD1064	5/32"	3-1/8"	1-3/4"	5/32"	\$6.42
600CD1264	3/16"	3-1/2"	2-3/16"	3/16"	\$6.59
600CD1664	1/4"	4-1/8"	2-9/16"	1/4"	\$7.23
600CD2064	5/16"	4-3/4"	3-5/32"	5/16"	\$8.46
600CD2464	3/8"	6"	4-3/8"	3/8"	\$9.74
600CD3264	1/2"	6-3/4"	4"	1/2"	\$17.79
600CD4064	5/8"	6"	4"	1/2"	\$23.33



- ◆ Multi Purpose
- ◆ Tungsten Carbide
- ◆ Turbo Flute
- ◆ Heat Treated Body
- ◆ Polished Finish
- ◆ High Wearability
- ◆ Straight Shank
- ◆ ANSI Specification

- Brick
- Concrete
- Tile
- Marble
- Fiberglass
- Metal
- Wood

**"THE PERFECT CARBIDE BIT FOR ANY FASTENING OR RENOVATION JOB!!!"**

This drill bit is specially developed for efficient *rotary* drilling in a wide range of materials in one operation without changing the drill bit. Ideal for cordless machines and any fastening jobs where drilling in different materials is necessary.

**ROTATION ONLY**



### Hard Steel Drill - Left Hand

Part #	Size	X	OAL	Shank	List
LHB-20	3/16"	X	3"	3/16"	\$13.80
LHB-22	1/4"	X	4"	1/4"	\$15.31
LHB-26	5/16"	X	4"	1/4"	\$16.59
LHB-32	3/8"	X	6"	3/8"	\$19.71
LHB-50	1/2"	X	6"	1/2"	\$34.79

### Hard Steel Drill - Right Hand

Part #	Size	X	OAL	Shank	List
RHB-20	3/16"	X	3"	3/16"	\$11.32
RHB-22	1/4"	X	4"	1/4"	\$12.84
RHB-26	5/16"	X	4"	1/4"	\$13.98
RHB-32	3/8"	X	6"	3/8"	\$15.49
RHB-50	1/2"	X	6"	1/2"	\$30.20

- ◆ Carbide Tip
- ◆ Tempered Body
- ◆ ANSI B212.15-1994

- Broken Bolts
- Freeze Plugs
- Bearing Races
- Safes
- Shafts
- Gears
- Industrial Parts

**Made In**





## Slow Spiral Masonry Drills

- ◆ General Purpose
- ◆ Tungsten Carbide
- ◆ Slow Spiral Flute
- ◆ Tempered Body
- ◆ Black Oxide Finish
- ◆ Gold Head
- ◆ Straight Shank
- ◆ ANSI Specification

- Brick
- Drywall
- Clay Pipe
- Tile
- Slate
- Cinder Block



**Use with rotation or Percussion**

A first generation carbide tipped drill bit, mass produced since the early 1970's, first in Europe, then in Puerto Rico, then in the USA. Still used ubiquitously and found in anchor kits all over the world.

Part #	Size	X	OAL	Drilling	Shank	List
502SP4001	1/8"	X	3"	1-1/2"	1/8"	\$1.35
502SP4002	3/16"	X	4"	2-1/2"	3/16"	\$1.48
502SP6001	3/16"	X	6"	4"	3/16"	\$2.66
502SP4732	7/32"	X	4"	2-1/2"	7/32"	\$1.58
502SP4003	1/4"	X	4"	2-1/2"	1/4"	\$1.61
502SP6002	1/4"	X	6"	4"	1/4"	\$2.84
502SP1201	1/4"	X	12"	10"	1/4"	\$6.26
502SP1814	1/4"	X	18"	16"	1/4"	\$8.33
502SP4004	5/16"	X	4"	2-1/2"	1/4"	\$1.98
502SP6003	5/16"	X	6"	4"	1/4"	\$3.39
502SP1202	5/16"	X	12"	10"	1/4"	\$7.10
502SP1856	5/16"	X	18"	16"	5/16"	\$9.35
502SP4005	3/8"	X	4"	2-1/2"	1/4"	\$2.65
502SP6004	3/8"	X	6"	4"	3/8"	\$3.83
502SP1203	3/8"	X	12"	10"	3/8"	\$8.41
502SP1838	3/8"	X	18"	16"	3/8"	\$10.95
502SP2438	3/8"	X	24"	22"	3/8"	\$14.65
502SP6005	7/16"	X	6"	4"	1/4"	\$3.95
502SP4006	1/2"	X	4"	2-1/2"	1/4"	\$3.95
502SP6007	1/2"	X	6"	4"	3/8"	\$4.08
502SP1204	1/2"	X	12"	10"	3/8"	\$9.43
502SP1812	1/2"	X	18"	16"	3/8"	\$12.21
502SP6008	9/16"	X	6"	4"	3/8"	\$6.55
502SP6009	5/8"	X	6"	4"	3/8"	\$7.19
502SP1205	5/8"	X	12"	10"	3/8"	\$13.33
502SP1858	5/8"	X	18"	16"	3/8"	\$16.99
502SP6010	3/4"	X	6"	4"	1/2"	\$9.34
502SP1206	3/4"	X	12"	10"	1/2"	\$16.85
502SP1834	3/4"	X	18"	16"	1/2"	\$21.71
502SP6011	7/8"	X	6"	4"	1/2"	\$10.92
502SP1207	7/8"	X	12"	10"	1/2"	\$18.94
502SP1878	7/8"	X	18"	16"	1/2"	\$23.87
502SP6012	1"	X	6"	4"	1/2"	\$14.47
502SP1208	1"	X	12"	10"	1/2"	\$21.35
502SP1801	1"	X	18"	16"	1/2"	\$28.69



## Roto Percussion Drills - Super Shlager

Part #	Size	X	OAL	Drilling	Shank	List
700040864	1/8"	X	3"	1-1/2"	1/8"	\$4.03
700061064	5/32"	X	6"	4"	5/32"	\$5.13
700041264	3/16"	X	3-1/2"	1-3/4"	3/16"	\$4.28
700061264	3/16"	X	6"	4"	3/16"	\$4.50
700061464	7/32"	X	6"	4"	7/32"	\$5.93
700041664	1/4"	X	4"	2-1/2"	1/4"	\$4.28
700061664	1/4"	X	6"	4"	1/4"	\$5.17
700081664	1/4"	X	12"	10"	1/4"	\$11.73
700024166	1/4"	X	24"	20"	1/4"	\$23.28
700041864	9/32"	X	4"	2-1/2"	1/4"	\$5.07
700042064	5/16"	X	4-3/4"	3-1/2"	5/16"	\$5.32
700062064	5/16"	X	6"	4"	5/16"	\$7.33
700062464	3/8"	X	6"	4"	3/8"	\$6.67
700082464	3/8"	X	12"	10"	3/8"	\$13.57
700020246	3/8"	X	20"	16"	3/8"	\$21.27
700024246	3/8"	X	24"	20"	3/8"	\$26.40
700062864	7/16"	X	6"	4"	3/8"	\$10.94
700063264	1/2"	X	6"	4"	3/8"	\$10.57
700083264	1/2"	X	12"	10"	3/8"	\$19.74
700020326	1/2"	X	20"	16"	3/8"	\$25.42
700024326	1/2"	X	24"	20"	3/8"	\$30.43
700063664	9/16"	X	6"	4"	Hex 3/8"	\$15.22
700064064	5/8"	X	6"	4"	Hex 3/8"	\$15.95
700084064	5/8"	X	12"	10"	Hex 3/8"	\$25.18
700024406	5/8"	X	24"	20"	Hex 1/2"	\$34.22
700064864	3/4"	X	6"	4"	Hex 1/2"	\$20.35
700084864	3/4"	X	12"	10"	Hex 1/2"	\$28.97
700065664	7/8"	X	6"	4"	Hex 1/2"	\$24.20
700085664	7/8"	X	12"	10"	Hex 1/2"	\$39.72
700066464	1"	X	6"	4"	Hex 1/2"	\$28.60
700086464	1"	X	12"	10"	Hex 1/2"	\$45.77
700024646	1"	X	24"	20"	Hex 1/2"	\$80.18

## Made For Hammer Drills!

- ◆ Heavy Duty
- ◆ Percussion Grade Tungsten Carbide
- ◆ Unique Spiral Flute for Fast Dust Removal
- ◆ Heat Treated Body
- ◆ Polished Finish
- ◆ Hex Shank on Larger Diameters to Prevent Slipping
- ◆ ANSI Specification

- Brick
- Cinder Block
- Up To 3000 psi Concrete
- Granite



SOLD INDIVIDUALLY.  
1 PER TUBE.



These Drill Bits are made for machines with percussion. They will not perform with rotation only.



# SDS-PLUS ROTARY HAMMER DRILLS



**Chisel Shaped Head Geometry** - Fast Penetration  
**High Volume Flute** - Fast Dust Removal



**REDLINE** P. 81

- ◆ ANSI Specification
- ◆ Made in Germany

- Mild Concrete
- Brick
- Stone
- Masonry
- Aggregates



**Serrated Head Geometry and Self Centering Tip** - Easy Spot Drilling  
**Web Shaped Head** - Improved Dust Release to Flute.  
**High Volume Flute** - Faster Debris Removal  
**Flute Core Reinforcement** - Reduces Vibrations  
**Rebar Chamfers** - Prevents Carbide From Cracking When in Contact with Rebar



**BOHR HAMMER** P. 82-85

- ◆ ANSI Specification
- ◆ Made in Germany

- Concrete
- Brick
- Stone
- Masonry
- Aggregates



**4 x 90° X-Cutter Carbide Head** - Crushes Through and Prevents Sticking in Rebar  
**Wear Mark Indicator** - Ensures Dimensional Hole Accuracy  
**Rebar Chamfers** - Prevents Carbide From Cracking When in Contact With Rebar  
**More Carbide Mass** - Extra Carbide Compared to Bohr Hammer  
**Flute Core Reinforcement** - Reduces Vibrations



**X-CUTTER** P.86

- ◆ ANSI Specification
- ◆ Made in Germany

- Reinforced Concrete
- Brick
- Stone
- Masonry
- Aggregates



**4 x 90° Serrated Tip Carbide Head** - Crushes Through and Prevents Sticking in Rebar  
**High Helix Geometry Flute** - For Torsional Stress and Getting Debris to Flute  
**Rebar Chamfers** - Prevents Carbide From Cracking When in Contact With Rebar  
**4 Fluted Geometry** - Evenly Distributes Flute Load for Less Flute Wear  
**Maximum Core Reinforcement** - Reduces Vibrations



**eVolution** P. 87

- ◆ ANSI Specification
- ◆ Made in Germany

- Reinforced Concrete
- Brick
- Stone
- Masonry
- Aggregates

# REDLINE

## SDS-PLUS Rotary Hammer Drills

Part #	Size	X	OAL	Drilling	Qty.	List
RL-41064	5/32"	X	4-1/4"	2"	1	\$3.99
RL-61064	5/32"	X	6-1/4"	4"	1	\$4.64
RL-61064-B	5/32"	X	6-1/4"	4"	25	\$108.10
RL-41264	3/16"	X	4-1/4"	2"	1	\$3.41
RL-61264	3/16"	X	6-1/4"	4"	1	\$4.52
RL-61264-B	3/16"	X	6-1/4"	4"	25	\$105.23
RL-81264	3/16"	X	8-1/4"	6"	1	\$6.29
RL-81264-B	3/16"	X	8-1/4"	6"	25	\$148.47
RL-41664	1/4"	X	4-1/4"	2"	1	\$3.34
RL-41664-B	1/4"	X	4-1/4"	2"	25	\$76.48
RL-61664	1/4"	X	6-1/4"	4"	1	\$3.99
RL-61664-B	1/4"	X	6-1/4"	4"	25	\$91.81
RL-81664	1/4"	X	8-1/4"	6"	1	\$5.52
RL-81664-B	1/4"	X	8-1/4"	6"	25	\$129.57
RL-62064	5/16"	X	6-1/4"	4"	1	\$4.37
RL-62064-B	5/16"	X	6-1/4"	4"	25	\$102.35
RL-62464	3/8"	X	6-1/4"	4"	1	\$4.79
RL-62464-B	3/8"	X	6-1/4"	4"	25	\$111.94
RL-12038	3/8"	X	12-1/4"	10"	1	\$9.58
RL-12038-B	3/8"	X	12-1/4"	10"	20	\$187.46
RL-63264	1/2"	X	6-1/4"	4"	1	\$6.25
RL-63264-B	1/2"	X	6-1/4"	4"	25	\$149.12
RL-12012	1/2"	X	12-1/4"	10"	1	\$11.00
RL-12012-B	1/2"	X	12-1/4"	10"	10	\$107.53
RL-63664	9/16"	X	6-1/4"	4"	1	\$9.58
RL-84064	5/8"	X	8-1/4"	6"	1	\$13.30
RL-84064-B	5/8"	X	8-1/4"	6"	10	\$129.18
RL-12058	5/8"	X	12"	10"	1	\$17.90
RL-84864	3/4"	X	8"	6"	1	\$19.05
RL-84864-B	3/4"	X	8"	6"	10	\$188.60
RL-12034	3/4"	X	12"	10"	1	\$24.46
RL-12034-B	3/4"	X	12"	10"	5	\$121.90
RL-85664	7/8"	X	8"	6"	1	\$28.25
RL-85664-B	7/8"	X	8"	6"	5	\$140.68
RL-12078	7/8"	X	12"	10"	1	\$32.12
RL-12078-B	7/8"	X	12"	10"	5	\$160.62
RL-10001	1"	X	10"	8"	1	\$36.23
RL-10001-B	1"	X	10"	8"	5	\$181.13



**For General Purpose Hammer Drilling In soft / medium / hard aggregates.**

- ◆ Rotary Hammer Drill
- ◆ ANSI Specification
- ◆ Made in GERMANY

- ➔ Mild Concrete
- ➔ Brick
- ➔ Stone
- ➔ Masonry
- ➔ Aggregates



This German Made Hammer Drill is a return to the original flute design of the 1970's. It's easier to make with today's high-tech fabrication machines and costs less. A very good drill for light to medium aggregates. Competes perfectly with Asian imports.



## BOHR HAMMER

### SDS-PLUS Rotary Hammer Drills

- ◆ Rotary Hammer Drill
- ◆ Serrated Head Geometry
- ◆ Self Centering Chisel Point
- ◆ ANSI Specification
- ◆ Special Tungsten Carbide Tip
- ◆ Copper / Silver Brazing
- ◆ Fastest Dust Removal
- ◆ Fastest Drilling Speeds
- ◆ Clean Round Holes
- ◆ Less Vibration
- ◆ Polished Finish
- ◆ Industrial Quality

- Concrete
- Brick
- Stone
- Masonry
- Aggregates



SOLD INDIVIDUALLY.  
1 PER CLIP.

**715Sxxxxx-B**  
Bulk Pack/Tube



Part #	Size	X	OAL	Drilling	Head	Qty.	List
715S41064	5/32"	X	4-1/4"	2"	4-PLUS	1	\$5.97
715S61064	5/32"	X	6-1/4"	4"	4-PLUS	1	\$6.81
715S61064-B	5/32"	X	6-1/4"	4"	4-PLUS	25	\$161.74
715S41264	3/16"	X	4-1/2"	2"	4-PLUS	1	\$5.97
715S41264-B	3/16"	X	4-1/2"	2"	4-PLUS	25	\$141.79
715S61264	3/16"	X	6-1/2"	4"	4-PLUS	1	\$6.81
715S61264-B	3/16"	X	6-1/2"	4"	4-PLUS	25	\$161.74
715S81264	3/16"	X	8-1/2"	6"	4-PLUS	1	\$9.42
715S81264-B	3/16"	X	8-1/2"	6"	4-PLUS	25	\$223.73
715S10316	3/16"	X	10-1/2"	8"	4-PLUS	1	\$12.50
715S12316	3/16"	X	12-1/2"	10"	4-PLUS	1	\$15.50
715S14316	3/16"	X	14"	12"	4-PLUS	1	\$22.59
715S16316	3/16"	X	16"	14"	4-PLUS	1	\$29.66
715S20316	3/16"	X	20"	18"	4-PLUS	1	\$48.42
715S24316	3/16"	X	24"	22"	4-PLUS	1	\$57.60
715S41464	7/32"	X	4-1/2"	2"	4-PLUS	1	\$6.99
715S61464	7/32"	X	6-1/2"	4"	4-PLUS	1	\$7.22
715S81464	7/32"	X	8-1/2"	6"	4-PLUS	1	\$8.97
715S11732	7/32"	X	10-1/2"	8"	4-PLUS	1	\$16.21
715S16732	7/32"	X	16"	14"	4-PLUS	1	\$28.21
715S20732	7/32"	X	20"	18"	4-PLUS	1	\$46.11
715S24732	7/32"	X	24"	22"	4-PLUS	1	\$54.86
715S41664	1/4"	X	4-1/2"	2"	4-PLUS	1	\$5.97
715S41664-B	1/4"	X	4-1/2"	2"	4-PLUS	25	\$141.79
715S61664	1/4"	X	6-1/2"	4"	4-PLUS	1	\$6.25
715S61664-B	1/4"	X	6-1/2"	4"	4-PLUS	25	\$148.44
715S81664	1/4"	X	8-1/2"	6"	4-PLUS	1	\$8.97
715S81664-B	1/4"	X	8-1/2"	6"	4-PLUS	25	\$213.04
715S11014	1/4"	X	10-1/2"	8"	4-PLUS	1	\$11.45
715S14014	1/4"	X	14"	12"	4-PLUS	1	\$22.45
715S16014	1/4"	X	16"	14"	4-PLUS	1	\$26.22
715S20014	1/4"	X	20"	18"	4-PLUS	1	\$35.24
715S24014	1/4"	X	24"	22"	4-PLUS	1	\$40.54
715S62064	5/16"	X	6-1/2"	4"	4-PLUS	1	\$8.31
715S62064-B	5/16"	X	6-1/2"	4"	4-PLUS	25	\$197.36
715S82064	5/16"	X	8-1/2"	6"	4-PLUS	1	\$11.02
715S12516	5/16"	X	12-1/2"	10"	4-PLUS	1	\$20.75
715S62464	3/8"	X	6-1/2"	4"	4-PLUS	1	\$9.03
715S62464-B	3/8"	X	6-1/2"	4"	4-PLUS	25	\$214.46
715S82464	3/8"	X	8-1/2"	6"	4-PLUS	1	\$10.42
715S10038	3/8"	X	10-1/2"	8"	4-PLUS	1	\$14.61
715S12038	3/8"	X	12-1/2"	10"	4-PLUS	1	\$18.53
715S12038-B	3/8"	X	12-1/2"	10"	4-PLUS	10	\$176.04
715S18038	3/8"	X	18"	16"	4-PLUS	1	\$28.72
715S24038	3/8"	X	24"	22"	4-PLUS	1	\$36.39
715S62864	7/16"	X	6-1/2"	4"	4-PLUS	1	\$12.44
715S10716	7/16"	X	10-1/2"	8"	4-PLUS	1	\$17.56
715S12716	7/16"	X	12-1/2"	10"	4-PLUS	1	\$20.56
715S18716	7/16"	X	18"	16"	4-PLUS	1	\$31.33

# BOHR HAMMER

## SDS-PLUS Rotary Hammer Drills

Part #	Size	X	OAL	Drilling	Head	Qty.	List
715S63264	1/2"	X	6-1/2"	4"	4-PLUS	1	\$10.39
715S63264-B	1/2"	X	6-1/2"	4"	4-PLUS	25	\$246.76
715S10012	1/2"	X	10-1/2"	8"	4-PLUS	1	\$17.93
715S12012	1/2"	X	12-1/2"	10"	4-PLUS	1	\$21.56
715S12012-B	1/2"	X	12-1/2"	10"	4-PLUS	10	\$185.82
715S12018	1/2"	X	18"	16"	4-PLUS	1	\$30.02
715S12024	1/2"	X	24"	22"	4-PLUS	1	\$47.10
715S63664	9/16"	X	6-1/4"	4"	4-PLUS	1	\$16.10
715S10916	9/16"	X	10-1/4"	8"	4-PLUS	1	\$21.79
715S12916	9/16"	X	12-1/4"	10"	4-PLUS	1	\$25.14
715S18916	9/16"	X	18"	16"	4-PLUS	1	\$32.60
715S64064	5/8"	X	6-1/4"	4"	4-PLUS	1	\$12.83
715S84064	5/8"	X	8-1/4"	6"	4-PLUS	1	\$18.43
715S84064-B	5/8"	X	8-1/4"	6"	4-PLUS	10	\$175.09
715S12058	5/8"	X	12-1/4"	10"	4-PLUS	1	\$26.72
715S18058	5/8"	X	18"	16"	4-PLUS	1	\$38.19
715S24058	5/8"	X	24"	22"	4-PLUS	1	\$47.21
715S14464	11/16"	X	12"	10"	4-PLUS	1	\$39.75
715S84864	3/4"	X	8"	6"	4-PLUS	1	\$23.72
715S84864-B	3/4"	X	8"	6"	4-PLUS	10	\$225.34
715S10034	3/4"	X	10"	8"	4-PLUS	1	\$29.26
715S12034	3/4"	X	12"	10"	4-PLUS	1	\$34.61
715S12034-B	3/4"	X	12"	10"	4-PLUS	5	\$164.40
715S18034	3/4"	X	18"	16"	4-PLUS	1	\$46.35
715S24034	3/4"	X	24"	22"	4-PLUS	1	\$60.67
715S85664	7/8"	X	8"	6"	4-PLUS	1	\$41.59
715S85664-B	7/8"	X	8"	6"	4-PLUS	5	\$197.55
715S10078	7/8"	X	10"	8"	4-PLUS	1	\$44.48
715S12078	7/8"	X	12"	10"	4-PLUS	1	\$46.93
715S12078-B	7/8"	X	12"	10"	4-PLUS	5	\$222.92
715S18078	7/8"	X	18"	16"	4-PLUS	1	\$52.01
715S86464	1"	X	8"	6"	4-PLUS	1	\$46.24
715S10001	1"	X	10"	8"	4-PLUS	1	\$51.88
715S10001-B	1"	X	10"	8"	4-PLUS	5	\$246.43
715S12001	1"	X	12"	10"	4-PLUS	1	\$54.72
715S18001	1"	X	18"	16"	4-PLUS	1	\$73.33



### 4-PLUS

A new, fast and tough serrated carbide tip provides long life, easy centering, and fast drilling through all aggregates, concrete, masonry, brick and natural stone.

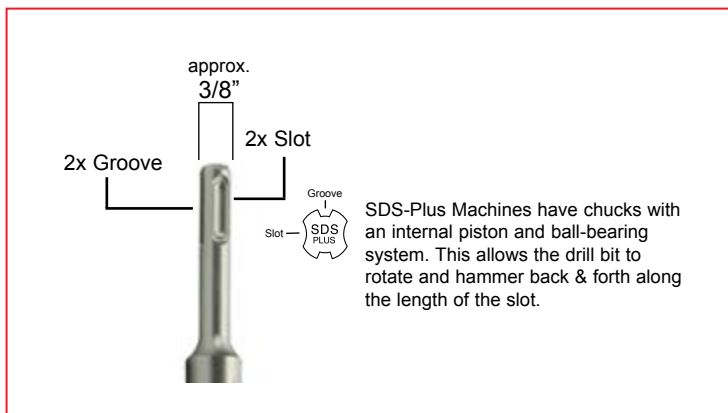

## BOHR HAMMER - BULK DRILLS

### SDS-PLUS Rotary Hammer Drills

- ◆ Rotary Hammer Drill
- ◆ Serrated Head Geometry
- ◆ Self Centering Chisel Point
- ◆ ANSI Specification
- ◆ Special Tungsten Carbide Tip
- ◆ Copper / Silver Brazing
- ◆ Fastest Dust Removal
- ◆ Fastest Drilling Speeds
- ◆ Clean Round Holes
- ◆ Less Vibration
- ◆ Polished Finish
- ◆ Industrial Quality

- Concrete
- Brick
- Stone
- Masonry
- Aggregates



Part #	Size	X	OAL	Drilling	Pack	Min.Qty.	List/ea.
715B41064	5/32"	X	4-1/4"	2"	BULK	50	\$5.97
715B61064	5/32"	X	6-1/4"	4"	BULK	50	\$6.81
715B41264	3/16"	X	4-1/2"	2"	BULK	50	\$5.97
715B61264	3/16"	X	6-1/2"	4"	BULK	100	\$6.81
715B81264	3/16"	X	8-1/2"	6"	BULK	50	\$9.42
715B10316	3/16"	X	10-1/2"	8"	BULK	25	\$12.50
715B12316	3/16"	X	12-1/2"	10"	BULK	25	\$15.50
715B14316	3/16"	X	14"	12"	BULK	25	\$22.59
715B16316	3/16"	X	16"	14"	BULK	25	\$29.66
715B20316	3/16"	X	20"	18"	BULK	25	\$48.42
715B24316	3/16"	X	24"	22"	BULK	25	\$57.60
715B41464	7/32"	X	4-1/2"	2"	BULK	50	\$6.99
715B61464	7/32"	X	6-1/2"	4"	BULK	50	\$7.22
715B81464	7/32"	X	8-1/2"	6"	BULK	50	\$8.97
715B11732	7/32"	X	10-1/2"	8"	BULK	25	\$16.21
715B16732	7/32"	X	16"	14"	BULK	25	\$28.21
715B20732	7/32"	X	20"	18"	BULK	25	\$46.11
715B24732	7/32"	X	24"	22"	BULK	25	\$54.86



# BOHR HAMMER - BULK DRILLS

## SDS-PLUS Rotary Hammer Drills

Part #	Size	X	OAL	Drilling	Pack	Min.Qty.	List/ea.
715B41664	1/4"	X	4-1/2"	2"	BULK	50	\$5.97
715B61664	1/4"	X	6-1/2"	4"	BULK	100	\$6.25
715B81664	1/4"	X	8-1/2"	6"	BULK	50	\$8.97
715B11014	1/4"	X	10-1/2"	8"	BULK	50	\$11.45
715B14014	1/4"	X	14"	12"	BULK	25	\$22.45
715B16014	1/4"	X	16"	14"	BULK	25	\$26.22
715B20014	1/4"	X	20"	18"	BULK	25	\$35.24
715B24014	1/4"	X	24"	22"	BULK	25	\$40.54
715B62064	5/16"	X	6-1/2"	4"	BULK	50	\$8.31
715B82064	5/16"	X	8-1/2"	6"	BULK	25	\$11.02
715B12516	5/16"	X	12-1/2"	10"	BULK	25	\$20.75
715B62464	3/8"	X	6-1/2"	4"	BULK	100	\$9.03
715B82464	3/8"	X	8-1/2"	6"	BULK	50	\$10.42
715B10038	3/8"	X	10-1/2"	8"	BULK	25	\$14.61
715B12038	3/8"	X	12-1/2"	10"	BULK	25	\$18.53
715B18038	3/8"	X	18"	16"	BULK	25	\$28.72
715B24038	3/8"	X	24"	22"	BULK	25	\$36.39
715B63264	1/2"	X	6-1/2"	4"	BULK	100	\$10.39
715B10012	1/2"	X	10-1/2"	8"	BULK	25	\$17.93
715B12012	1/2"	X	12-1/2"	10"	BULK	25	\$21.56
715B12018	1/2"	X	18"	16"	BULK	25	\$30.02
715B12024	1/2"	X	24"	22"	BULK	25	\$47.10



### 4-PLUS

A new, fast and tough serrated carbide tip provides long life, easy centering, and fast drilling through all aggregates, concrete, masonry, brick and natural stone.

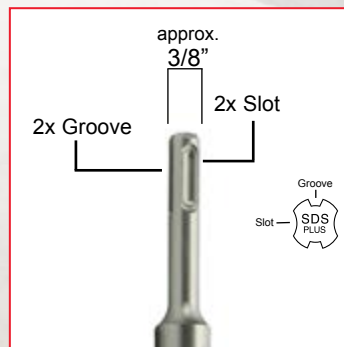



- ◆ Rotary Hammer Drill
- ◆ Self Centering Chisel Point
- ◆ ANSI Specification
- ◆ Special Tungsten Carbide Tip
- ◆ Copper / Silver Brazing
- ◆ Fast Dust Removal
- ◆ Fast Drilling Speeds
- ◆ Clean Round Holes
- ◆ Less Vibration
- ◆ Polished Finish
- ◆ Industrial Quality

- Reinforced Concrete
- Brick
- Stone
- Masonry
- Aggregates



SOLD INDIVIDUALLY.  
1 PER TUBE.



## X-CUTTER *DRILLS REINFORCED CONCRETE!*

### SDS-PLUS Rotary Hammer Drills

Part #	Size	X	OAL	Drilling	Head	List
750TE010	5/8"	X	8-1/4"	6"	X-CUTTER	\$25.23
750TE020	5/8"	X	10-1/4"	8"	X-CUTTER	\$26.84
750TE030	5/8"	X	12-1/4"	10"	X-CUTTER	\$34.71
750TE040	5/8"	X	18"	16"	X-CUTTER	\$44.24
750TE090	3/4"	X	8"	6"	X-CUTTER	\$43.46
750TE100	3/4"	X	10"	8"	X-CUTTER	\$46.20
750TE110	3/4"	X	12"	10"	X-CUTTER	\$52.07
750TE120	3/4"	X	18"	16"	X-CUTTER	\$60.38
750TE140	7/8"	X	8"	6"	X-CUTTER	\$56.76
750TE150	7/8"	X	10"	8"	X-CUTTER	\$60.23
750TE160	7/8"	X	12"	10"	X-CUTTER	\$68.20
750TE170	7/8"	X	18"	16"	X-CUTTER	\$72.11
750TE190	1"	X	10"	8"	X-CUTTER	\$66.49
750TE200	1"	X	12"	10"	X-CUTTER	\$79.44
750TE210	1"	X	18"	16"	X-CUTTER	\$90.30
750TE220	1-1/8"	X	10"	8"	X-CUTTER	\$98.56
750TE230	1-1/8"	X	18"	16"	X-CUTTER	\$100.22
750TE240	1-1/4"	X	18"	16"	X-CUTTER	\$109.02



#### X-Cutter

- ◆ 4 x 90° Head Symmetry
- ◆ Centering Tip for Pinpoint Accuracy
- ◆ Rebar Chamfers
- ◆ Maximum Carbide / Steel Interface
- ◆ Low Vibration for Increased Rotational Stability
- ◆ ANSI Specification

**eVolution™**

**DRILLS REINFORCED CONCRETE!**

**SDS-PLUS Rotary Hammer Drills**

Part #	Size	X	OAL	Drilling	Head	Qty.	List
EVL41064	5/32"	X	4-1/2"	2"	4X4	1	\$10.03
EVL61064	5/32"	X	6-1/2"	4"	4X4	1	\$11.20
EVL41264	3/16"	X	4-1/2"	2"	4X4	1	\$10.30
EVL61264	3/16"	X	6-1/2"	4"	4X4	1	\$11.20
EVL61264-B	3/16"	X	6-1/2"	4"	4X4	25	\$260.67
EVL81264	3/16"	X	8-1/2"	6"	4X4	1	\$14.70
EVL10316	3/16"	X	10-1/2"	8"	4X4	1	\$20.92
EVL12316	3/16"	X	12-1/2"	10"	4X4	1	\$25.78
EVL41664	1/4"	X	4-1/2"	2"	4X4	1	\$9.84
EVL61664	1/4"	X	6-1/2"	4"	4X4	1	\$10.81
EVL61664-B	1/4"	X	6-1/2"	4"	4X4	25	\$251.08
EVL81664	1/4"	X	8-1/2"	6"	4X4	1	\$13.92
EVL10014	1/4"	X	10-1/2"	8"	4X4	1	\$21.31
EVL12014	1/4"	X	12-1/2"	10"	4X4	1	\$29.67
EVL62064	5/16"	X	6-1/2"	4"	4X4	1	\$12.56
EVL62064-B	5/16"	X	6-1/2"	4"	4X4	25	\$294.21
EVL12516	5/16"	X	12-1/2"	10"	4X4	1	\$23.64
EVL18516	5/16"	X	18"	16"	4X4	1	\$34.92
EVL62464	3/8"	X	6-1/4"	4"	4X4	1	\$13.92
EVL62464-B	3/8"	X	6-1/4"	4"	4X4	25	\$327.75
EVL12038	3/8"	X	12-1/4"	10"	4X4	1	\$23.64
EVL18038	3/8"	X	18"	16"	4X4	1	\$37.84
EVL62864	7/16"	X	6-1/4"	4"	4X4	1	\$18.78
EVL12716	7/16"	X	12-1/4"	10"	4X4	1	\$27.34
EVL18716	7/16"	X	18"	16"	4X4	1	\$38.81
EVL63264	1/2"	X	6-1/4"	4"	4X4	1	\$18.28
EVL63264-B	1/2"	X	6-1/4"	4"	4X4	25	\$433.17
EVL12012	1/2"	X	12-1/4"	10"	4X4	1	\$29.09
EVL18012	1/2"	X	18"	16"	4X4	1	\$39.39
EVL63664	9/16"	X	6-1/4"	4"	4X4	1	\$24.69
EVL12916	9/16"	X	12-1/4"	10"	4X4	1	\$36.09
EVL18916	9/16"	X	18"	16"	4X4	1	\$49.51



- ◆ Rotary Hammer Drill
- ◆ Serrated Head Geometry
- ◆ 4 Symmetrical Functioning Spiral Ridges
- ◆ ANSI Specification
- ◆ Drills Reinforced Concrete
- ◆ 50% More Holes
- ◆ Optimized Core Ensures Impact Durability and Rotational Stability
- ◆ High Break Resistance
- ◆ Less Vibration

- Reinforced Concrete
- Brick
- Stone
- Masonry
- Aggregates



SOLD INDIVIDUALLY.  
1 PER CLIP.



**4X4-Cutter**

- ◆ 4 x 90° Serrated Tip Geometry
- ◆ One-piece, Solid Carbide Tip
- ◆ Centering Tip for Pinpoint Accuracy
- ◆ Rebar Chamfers
- ◆ Maximum Carbide / Steel Interface
- ◆ Low Vibration for Increased Rotational Stability
- ◆ ANSI Specification





For Drop-in Anchors



### SDS-PLUS + STOP Rotary Hammer Bit

- ◆ Rotary Hammer Drill
- ◆ STOP - Lip Prevents Over-Drilling
- ◆ Drill Exact Depth For Drop-In Anchor
- ◆ Less Likely to Hit Rebar
- ◆ ANSI Specification



Part #	Size	Drill Depth	Anchor Size	Qty.	List
STP-617	3/8"	1-1/16"	1/4"	1	\$24.75
STP-813	1/2"	13/16"	3/8" Short	1	\$27.50
STP-827	1/2"	1-11/16"	3/8"	1	\$28.88
STP-1019	5/8"	1-3/16"	1/2" Short	1	\$30.92
STP-1033	5/8"	2-1/16"	1/2"	1	\$35.13
STP-418	7/8"	2-5/8"	5/8"	1	\$38.64
STP-419	1"	3-1/4"	3/4"	1	\$45.59

### Use Your SDS-Plus Drill Bits In Larger SDS-MAX® Or Spline Drive Machines:

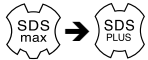

Adapter

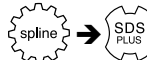

Adapter

### SDS-MAX® to SDS-PLUS

Part #	Description	List
725MAX001	SDS-MAX To SDS-Plus Adapter	\$114.15



### Spline to SDS-PLUS

Part #	Description	List
725SP001	Spline To SDS-Plus Adapter	\$118.12



### Replacement Kit - FOR ADAPTERS

Part #	Description	List
715KIT001	Gaskets & Ball Bearings	\$4.50

### SDS-Max to SDS-Plus Adapter



Half Flat Shank



### Concrete Bits - FOR CONCRETE SCREWS

Part #	Size	x	OAL	Screw	Qty.	List
602TC0503	5/32"	X	3-1/2"	12	50	\$3.17
602TC0500	5/32"	X	4-1/2"	12	50	\$3.31
602TC0505	5/32"	X	5-1/2"	12	50	\$3.60
602TC0603	3/16"	X	3-1/2"	14	50	\$3.60
602TC0604	3/16"	X	4-1/2"	14	50	\$3.73
602TC0605	3/16"	X	5-1/2"	14	50	\$4.01
602TC0606	3/16"	X	6-3/4"	14	50	\$4.72
602TC0607	3/16"	X	7-5/8"	14	50	\$5.67

- ◆ Industrial Quality
- ◆ Tungsten Carbide Tip
- ◆ ANSI Specification



Each concrete screw carbide drill bit is precisely ground to match a certain tolerance to assure proper hole diameter and to achieve maximum thread holding power. The flat on the shank fits all drill adapters. The drill bit is specially heat treated to make it very durable.



5/16" HEX SHOULDER



### SDS-HEX Bits - FOR CONCRETE SCREWS

Part #	Size	x	OAL	Drilling	Qty.	List
HEX5325	5/32"	X	5"	2-1/2"	1	\$10.92
HEX5327	5/32"	X	7"	4-1/2"	1	\$12.17
HEX3165	3/16"	X	5"	2-1/2"	1	\$10.92
HEX3167	3/16"	X	7"	4-1/2"	1	\$12.17
HEX2345	.234	X	5"	2-1/2"	1	\$10.92
HEX2347	.234	X	7"	4-1/2"	1	\$12.17

- ◆ Industrial Quality
- ◆ Special Tungsten Carbide Tip
- ◆ ANSI Specification
- ◆ Copper / Silver Brazing
- ◆ Polished Finish



SDS-HEX Rotary Hammer drill bits are specifically designed to be used in concrete screw installation. These SDS bits have a special 5/16" HEX shoulder for use with standard concrete screw installation sleeves, which eliminate the need for drill adapters. The benefits of using an SDS machine rather than a standard rotation drill means a decrease in operation time of nearly 50%. **SEE BELOW FOR INSTALLATION KIT**



### Concrete Screw Installation Sleeve

Part #	Description	Qty.	List
TPCDSL	6-1/2" Concrete Screw Sleeve	1	\$18.25



### Installation Kit

Part #	Description	List
602TC1000	Installation Kit	\$70.00

**INCLUDES:**

- 5/32" x 7" SDS-PLUS Hex Bit
- 3/16" x 7" SDS-PLUS Hex Bit
- 1/4" Magnetic Driver
- 5/16" Magnetic Driver
- Phillips Bit Adapter
- Masonry Drill Adapter
- 6-1/2" Sleeve
- 1/8" Hex Key
- Phillips #2 x 1" Insert
- Phillips #3 x 1" Insert



- ◆ Red Case
- ◆ Black Hardware

This Installation Kit is Suitable for both Standard Concrete Bits & SDS-HEX Rotary Hammer Bits.



SDS-PLUS ROTARY HAMMER DRILL MACHINES

BOSCH	DEWALT	HILTI	HITACHI	MAKITA	MILWAUKEE	METABO
11207	D25012K	TE 1	DH18DL	BHR202	0756-22	6010
11210	D25023K	TE 2	DH22PG	BHR241	2412-20	6011
11211	D25111K	TE 2-A	DH24	HR160	2416-20XC	6015
11212	D25123K	TE 2-A18	DH24PF3	HR1821	2605-20	6018
11215	D25133K	TE 2-M	DH25	HR1830	2612-22	6020
11524	D25211K	TE 2-S	DH28	HR1830F	2712-22	6021
11213RK	D25213K	TE 4-A18	DH28PC	HR2000	2715-22	6024
11221DVS	D25223K	TE 4-A22	DH28PD	HR2010	5262	6026
11222EVS/G	D25211K	TE 6-A36-AVR	DH30	HR2400	5262-21	6028
11224VSR	D25213K	TE 6-S	H30PV	HR2410	5263	BHA18
11225VSR/H	D25223K	TE 7	VR16	HR2420	5263-21	BHE22
11228VSR	D25260K	TE 7-A	VRT22	HR2431	5268-21	BHE2243
11234VSR	D25262K	TE 7-C		HR2432	5302	BHE24
11236VS	D25263K	TE 30		HR2450	5303	BHE2444
11239VS	D25313K	TE 30-A36		HR2455	5312	BHE2644
11250VSR	D25323K	TE 30-C-AVR		HR2470F	5320	BHE6015
11250VSRD	D25324K	TE 30-M-AVR		HR2475	5324	KHE24
11253VSR	D25404K	TE 40		HR2511	5342	KHE2444
11255VSR	D25413K	TE 40-AVR		HR2611F	5359	KHE2640
11536C-1(2)	D25416K	TE A-36AVR		HR2621	5359-21	KHE2644
11536VSR		TE/GP 22		HR2811F	5360	KHE3650
RH228VC				HR3000C	5362	KHE28
RH328VC(Q)				HR3210C	5363	KHE2851
RH432VC(Q)					5363-21	KHE32
RHH181-01					5365	KHE3250
RHH181BL					5366	KHE3251
RHS181B					5368	UHE22
RHS181K					5369	UHE2250
					5383	UHE2450
					V28	UHE2650
						UHE28
						UHE2850



SDS-MAX ROTARY HAMMER DRILL MACHINES

BOSCH	DEWALT	HILTI	HITACHI	MAKITA	MILWAUKEE	METABO
11214EVS	25600K	TE-F 52	DH38MS	HR4000C	5308	6045
1223	2570K	TE-F 60	DH40MA	HR4001C	5313	KHE 5-40
1227	541K	TE-F 72	DH40MB	HR4002	5314	KHE56
1230	545K	TE-F 92	DH40MRY	HR4002C	5315	KHE76
11216	D25501K	TE-Y 54	DH45MR	HR4010C	5317	KHE96
11231	D25601K	TE-Y 55	DH50MRY	HR4013C	5317-21	
11235	D25602K	TE-Y 56	H60HR	HR4500C	5342	
11240	D25603K	TE-Y 70		HR4510C	5342-21	
11241	D25712K	TE-Y 74		HR5001C	5346	
11245	D25721K	TE-Y 75		HR5210C	5426	
11245EVS	D25723K	TE-Y 76		HR5212C	5426-1	
11263	D25761K	TE50			5446	
11263EVS	D25762K	TE60				
11264	D25763K	TE60-ATC/AVR				
11264EVS		TE70				
RH540M		TE70-ATC/AVR				
RH745		TE80-ATC/AVR				
RH850VC						



SPLINE DRIVE ROTARY HAMMER DRILL MACHINES

BOSCH	DEWALT	HILTI	HITACHI	MAKITA	MILWAUKEE	METABO
11202	D25651K	N/A	DH38YE2	HR3851	5309	N/A
11203	D25553K		DH40FR	HR4040C	5311	
11204	530K		DS50SBK	HR4041C	5316	
11205	531K			HR5000	5316-21	
11209	532K				5317	
11214	533K				5318	
11219					5319	
11220					5321	
11232					5340-21	
11233					5341	
11247					5343	
11248					5344	
11244E					5347	
11265EVS					5348	
RH540S					5352	
					5345	

# X-CUTTER DRILLS REINFORCED CONCRETE!

## SDS-MAX® Rotary Hammer Drills

Part #	Size	X	OAL	Drilling	Head	List
SMTE1338	3/8"	X	13"	7-1/2"	REGULAR	\$45.79
SMTE1312	1/2"	X	13"	7-1/2"	REGULAR	\$44.29
SMTE1712	1/2"	X	17"	12"	REGULAR	\$55.43
SMTE2212	1/2"	X	21"	15-1/2"	REGULAR	\$58.49
SMTE1391	9/16"	X	13"	7-1/2"	REGULAR	\$68.72
SMTE2192	9/16"	X	21"	15-1/2"	REGULAR	\$89.71
SMTE1358	5/8"	X	13"	7-1/2"	X-CUTTER	\$53.44
SMTE1758	5/8"	X	17"	12"	X-CUTTER	\$60.80
SMTE2258	5/8"	X	21"	15-1/2"	X-CUTTER	\$64.61
SMTE3658	5/8"	X	36"	30-1/2"	X-CUTTER	\$139.79
SMTE2111	11/16"	X	21"	15-1/2"	X-CUTTER	\$93.42
SMTE1334	3/4"	X	13"	8"	X-CUTTER	\$55.40
SMTE1734	3/4"	X	17"	12"	X-CUTTER	\$65.63
SMTE2234	3/4"	X	21"	17"	X-CUTTER	\$72.24
SMTE3634	3/4"	X	36"	31"	X-CUTTER	\$152.62
SMTE2113	13/16"	X	21"	17"	X-CUTTER	\$99.29
SMTE1378	7/8"	X	13"	8"	X-CUTTER	\$65.23
SMTE1778	7/8"	X	17"	12"	X-CUTTER	\$74.77
SMTE2278	7/8"	X	21"	17"	X-CUTTER	\$78.85
SMTE3678	7/8"	X	36"	31"	X-CUTTER	\$201.56
SMTE1301	1"	X	13"	8"	X-CUTTER	\$71.37
SMTE1701	1"	X	17"	12"	X-CUTTER	\$82.44
SMTE2201	1"	X	21"	17"	X-CUTTER	\$86.65
SMTE3601	1"	X	36"	31"	X-CUTTER	\$214.18
SMTE2311	1-1/16"	X	23"	18"	X-CUTTER	\$117.16
SMTE1718	1-1/8"	X	17"	12"	X-CUTTER	\$94.64
SMTE2218	1-1/8"	X	21"	17"	X-CUTTER	\$111.93
SMTE3618	1-1/8"	X	36"	31"	X-CUTTER	\$242.70
SMTE2313	1-3/16"	X	23"	18"	X-CUTTER	\$144.41
SMTE1714	1-1/4"	X	15"	10"	X-CUTTER	\$122.87
SMTE2214	1-1/4"	X	23"	18"	X-CUTTER	\$131.29
SMTE3614	1-1/4"	X	36"	31"	X-CUTTER	\$256.60
SMTE1738	1-3/8"	X	17"	12"	X-CUTTER	\$137.07
SMTE2238	1-3/8"	X	23"	18"	X-CUTTER	\$144.49
SMTE3638	1-3/8"	X	36"	31"	X-CUTTER	\$289.82
SMTE1721	1-1/2"	X	17"	12"	X-CUTTER	\$169.44
SMTE2221	1-1/2"	X	23"	18"	X-CUTTER	\$214.98
SMTE2334	1-3/4"	X	23"	18"	X-CUTTER	\$304.16
SMTE2202	2"	X	23"	18"	X-CUTTER	\$337.26



- ◆ Rotary Hammer Drill
- ◆ Industrial Quality
- ◆ Special Tungsten Carbide Tip
- ◆ Copper / Silver Brazing
- ◆ Fastest Dust Removal
- ◆ Fastest Drilling Speeds
- ◆ Heat Treated Body
- ◆ Clean Round Holes
- ◆ Less Vibration
- ◆ Polished Finish
- ◆ ANSI Specification

- ➔ Reinforced Concrete
- ➔ Brick
- ➔ Stone
- ➔ Masonry
- ➔ Aggregates



SOLD INDIVIDUALLY.  
1 PER TUBE.



Extensions on Page 92.

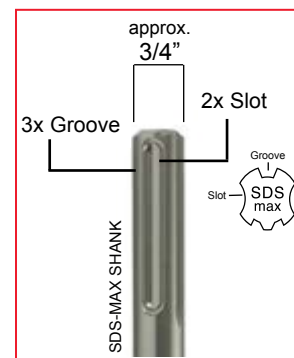

Bosch® License

## X-Tend Your Drilling Depths!



GERMANY

Drill bit extension system for all SDS-Max & Spline machines.

- ◆ X-Tend Any SDS-MAX Tool
- ◆ Quick & Safe Connection
- ◆ Simple To Use
- ◆ No Energy Loss
- ◆ No Weak Points
- ◆ Saves Time & Money
- ◆ Reduces Tool Requirements

### How it works:

- X-Tendr™ Adapter has double locking SDS-MAX inputs.
- All EXTENSION SHAFTS have 1 SDS-MAX end which locks into X-Tendr™ Adapter. Other end can be inserted into either an SDS-MAX or Spline machine.
- X-Tend any SDS-MAX drill bit, core bit, tunnel bore drill, drill head, or chisel.
- Reach of X-Tendr™ system limited to 1 adapter and 1 extension.



1. Choose either SDS-MAX or SPLINE Drive and desired length Extension.



2. Attach X-Tendr™ Adaptor to SDS-MAX end of Extension.



3. Attach desired SDS-MAX Rotary Hammer Drill Bit, Core Bit, Tunnel Bore Drill or Chisel.

Drill Bit Diameter Must Be 1-1/4" Or Larger if X-Tendr™ is to Pass Through Hole Being Drilled.



## X-Tendr™ - MAX to MAX SHANK ADAPTER

Part #	Description	List
XT6700	Adapter (1-3/16" x 7-1/2")	\$384.25
XT6750	Adapter Grease (Tube)	\$7.17

Drill Bit Diameter Must Be 1-1/4" Or Larger if X-Tendr™ is to Pass Through Hole Being Drilled.



SDS-Max Shaft



Spline Shaft

## X-Tendr™ Extension Shafts

Part #	OAL	Shank	List
XT6701	12-1/2"	SDS-MAX	\$60.67
XT6702	30"	SDS-MAX	\$74.58
XT6703	44"	SDS-MAX	\$101.79
XT6708	12-1/2"	SPLINE	\$74.28
XT6709	30"	SPLINE	\$92.98

## X-TEND YOUR OPTIONS...





## Exacto™ Center Pin

Part #	Size	List
EXA-CP0	#0 CENTER PIN (FOR 1" & 1-1/8")	\$67.88
EXA-CP1	#1 CENTER PIN (FOR 1-1/4", 1-3/8" & 1-1/2")	\$67.92
EXA-CP2	#2 CENTER PIN (FOR 1-3/4" THRU 3-7/8")	\$67.92



GUIDE PLATE INCLUDED WITH EACH CORE BIT



## Exacto™ Carbide Core Bit - 4" OAL

Part #	Size	# Teeth	Pin	Shank	List
EXA-25C	1"	5	EXA-CPO	EXA-S1-8	\$180.25
EXA-29C	1-1/8"	5	EXA-CPO	EXA-S1-8	\$192.21
EXA-32C	1-1/4"	6	EXA-CP1	EXA-S1-8	\$213.92
EXA-35C	1-3/8"	6	EXA-CP1	EXA-S1-8	\$237.88
EXA-38C	1-1/2"	7	EXA-CP1	EXA-S1-8	\$264.21
EXA-45C	1-3/4"	8	EXA-CP2	EXA-S2-8	\$300.25
EXA-50C	2"	9	EXA-CP2	EXA-S2-8	\$319.54
EXA-55C	2-1/8"	10	EXA-CP2	EXA-S2-8	\$336.08
EXA-65C	2-9/16"	12	EXA-CP2	EXA-S2-8	\$386.58
EXA-80C	3-1/8"	16	EXA-CP2	EXA-S2-8	\$472.92
EXA-90C	3-1/2"	16	EXA-CP2	EXA-S2-8	\$540.25
EXA-100C	3-7/8"	16	EXA-CP2	EXA-S2-8	\$602.67



## Exacto™ SDS-Plus Extension

Part #	Size	List
EXA-S1-8	8" EXTENSION (FOR 1" THRU 1-1/2")	\$59.54
EXA-S1-12	12" EXTENSION (FOR 1" THRU 1-1/2")	\$70.58
EXA-S2-8	8" EXTENSION (FOR 1-3/4" THRU 3-7/8")	\$79.25
EXA-S2-12	12" EXTENSION (FOR 1-3/4" THRU 3-7/8")	\$104.54



- ◆ Industrial Quality
- ◆ Tungsten Carbide Teeth
- ◆ Thin Wall Body
- ◆ Cutting Depth 2-3/4"
- ◆ Use Rotary Hammer Action
- ◆ Clean Round Holes

- Concrete
- Brick
- Stone
- Masonry
- Aggregates





### Pilot Drill - A-TAPER FOR EXTENSION

Part #	Size	List
721PD0385	3/8" X 6" A-TAPER	\$12.21

### Ejector Key

Part #	Description	List
722EJ0001	EJECTOR KEY	\$9.86



### Carbide Core Bit - 4" OAL / TAPER

Part #	Size	# Teeth	List
719CB0040	1-1/2"	6	\$121.30
719CB0050	2"	6	\$144.23
719CB0065	2-1/2"	9	\$156.35
719CB0080	3" (3-1/8")	9	\$204.54
719CB0090	3-1/2" (3-9/16")	9	\$230.73
719CB0100	4"	9	\$297.28
719CB0125	5"	12	\$396.48

All 3-1/2" Diameter Core Bits Are Now 3-9/16"

These Heavy Duty Rotary Hammer Core Bits are used with either Spline or SDS-MAX electric rotary hammer machines. The special alloy steel body and Tungsten Carbide withstand continuous hammering. A pilot drill bit and extension are required.



GERMANY



### Taper Shank Extensions



#### SPLINE DRIVE

Part #	Size	Shank	List
720SP0008	8"	SPLINE	\$77.28
720SP0018	18"	SPLINE	\$95.11



#### SDS - MAX®

Part #	Size	Shank	List
720MAX008	8"	SDS-MAX	\$88.02
720MAX018	18"	SDS-MAX	\$107.56



Notice: Core Bit drilling without the use of a pilot drill bit causes excessive pressure on the taper shank system. This can result in breakage to the extension at the tapered end, especially between the two slots. Such jagged breaks are not considered defective and may not be covered under warranty.

## 1-Pc SDS-MAX® Core Bits

Part #	Size	X	OAL	# Teeth	Shank	List
990HH1015	1-1/2"	X	12"	4	SDS-MAX	\$247.91
990HH1025	1-1/2"	X	22"	4	SDS-MAX	\$296.97
990HH1155	1-3/4"	X	12"	6	SDS-MAX	\$262.21
990HH1165	1-3/4"	X	22"	6	SDS-MAX	\$293.04
990HH1035	2"	X	12"	6	SDS-MAX	\$271.34
990HH1045	2"	X	22"	6	SDS-MAX	\$318.29
990HH1055	2-5/8"	X	12"	8	SDS-MAX	\$308.22
990HH1065	2-5/8"	X	22"	8	SDS-MAX	\$354.74
990HH1075	3-1/8"	X	12"	8	SDS-MAX	\$385.91
990HH1085	3-1/8"	X	22"	8	SDS-MAX	\$428.50
990HH1095	3-9/16"	X	12"	10	SDS-MAX	\$403.46
990HH1105	3-9/16"	X	22"	10	SDS-MAX	\$447.78
990HH1115	4"	X	12"	10	SDS-MAX	\$453.03
990HH1125	4"	X	22"	10	SDS-MAX	\$483.52
990HH1215	5"	X	12"	14	SDS-MAX	\$515.58
990HH1135	5"	X	22"	14	SDS-MAX	\$546.54
990HH1145	6"	X	22"	18	SDS-MAX	\$716.08

All 3-1/2" Diameter Core Bits Are Now 3-9/16"

## 1-Pc Spline Core Bits

Part #	Size	X	OAL	# Teeth	Shank	List
920HH1505	1-1/2"	X	12"	4	SPLINE	\$253.35
920HH1515	1-1/2"	X	22"	4	SPLINE	\$296.00
920HH1665	1-3/4"	X	12"	6	SPLINE	\$254.81
920HH1675	1-3/4"	X	22"	6	SPLINE	\$291.81
920HH1525	2"	X	12"	6	SPLINE	\$264.79
920HH1535	2"	X	22"	6	SPLINE	\$308.98
920HH1545	2-5/8"	X	12"	8	SPLINE	\$304.80
920HH1555	2-5/8"	X	22"	8	SPLINE	\$348.36
920HH1565	3-1/8"	X	12"	8	SPLINE	\$371.66
920HH1575	3-1/8"	X	22"	8	SPLINE	\$422.45
920HH1585	3-9/16"	X	12"	10	SPLINE	\$391.45
920HH1595	3-9/16"	X	22"	10	SPLINE	\$434.55
920HH1605	4"	X	12"	10	SPLINE	\$448.29
920HH1615	4"	X	22"	10	SPLINE	\$490.58
920HH1625	5"	X	12"	14	SPLINE	\$511.73
920HH1635	5"	X	22"	14	SPLINE	\$541.33
920HH1655	6"	X	22"	18	SPLINE	\$714.73

All 3-1/2" Diameter Core Bits Are Now 3-9/16"



## Pilot Drill & Key - REPLACEMENT PARTS

Part #	Size	List
900PD1143	7/16" X 4-3/4" PILOT DRILL	\$10.27
900DK7006	3/8" ROUND DRIFT KEY	\$9.80



- ◆ Industrial Quality
- ◆ 1 Piece Construction
- ◆ Special Tungsten Carbide Tip
- ◆ Copper / Silver Brazing
- ◆ Clean Round Holes
- ◆ Less Vibration
- ◆ Polished Finish

- ➔ Concrete
- ➔ Brick
- ➔ Stone
- ➔ Masonry
- ➔ Aggregates



Each Core Bit Includes Pilot Drill & Key

SOLD INDIVIDUALLY.  
1 PER TUBE.

**Asymmetrical Tooth Arrangement For Faster Drilling Process**





- ◆ Industrial Quality
- ◆ 1 Piece Construction
- ◆ Special Tungsten Carbide Tip
- ◆ Copper / Silver Brazing
- ◆ Fast Drilling Speed
- ◆ Clean Round Holes
- ◆ Less Vibration
- ◆ Polished Finish

- ➔ Concrete
- ➔ Brick
- ➔ Stone
- ➔ Masonry
- ➔ Aggregates



GERMANY

SOLD INDIVIDUALLY.  
1 PER TUBE.



## SDS-MAX® Tunnel Bore Drills

Part #	Size	X	OAL	Shank	List
950CC7331	1-1/2"	X	22"	SDS-MAX	\$281.87
950CC7333	1-3/4"	X	22"	SDS-MAX	\$287.20
950CC7342	1-3/4"	X	39"	SDS-MAX	\$380.63
950CC7337	2-1/8"	X	22"	SDS-MAX	\$323.83
950CC7343	2-1/8"	X	39"	SDS-MAX	\$427.15
950CC7339	2-1/2"	X	22"	SDS-MAX	\$328.94
950CC7344	2-1/2"	X	39"	SDS-MAX	\$460.98
950CC7341	3-1/8"	X	22"	SDS-MAX	\$391.75
950CC7345	3-1/8"	X	39"	SDS-MAX	\$528.65



Extensions on Page 92.

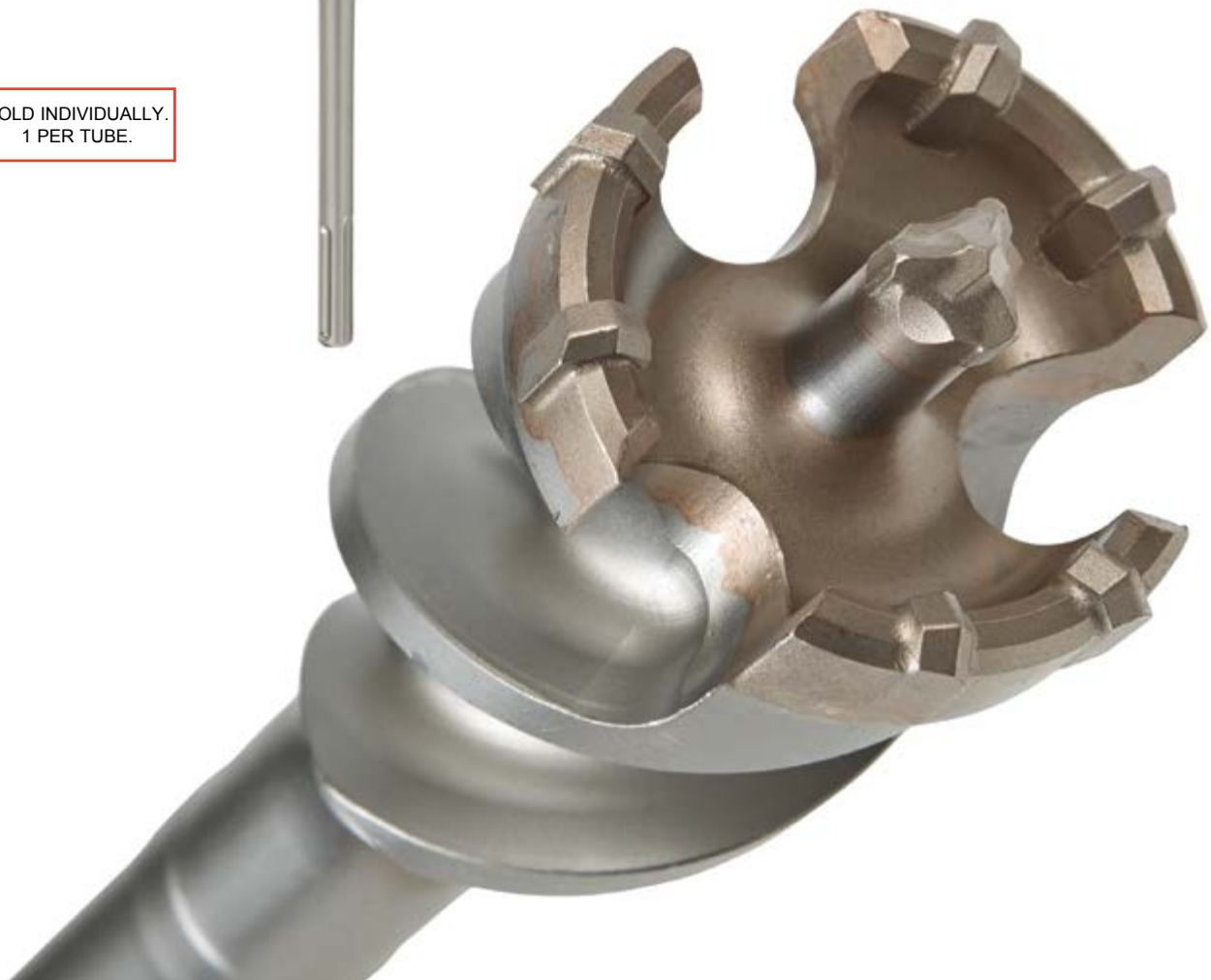

## Adapters

Part #	Description	OAL	List
800RA010	SPLINE ADAPTER	7"	\$78.14
800RA020	SDS-MAX ADAPTER	7"	\$78.14



◆ 5/8" - 11 Internal Thread



## Pilot Drills

Part #	Description	List
800RP124	5/8" X 4-3/4" PILOT	\$43.42
800RP174	5/8" X 6-3/4" PILOT	\$46.84
800RP255	1/2" X 6" PILOT	\$35.12



- RECOMMENDED.  
- BETTER FOR DEEP DRILLING.  
- FOR RATIO CORE BIT ONLY!!!

- ◆ Modular System
- ◆ Up to 6" Diameter
- ◆ Allows for Angle Drilling
- ◆ Use With or Without Spiral Flute
- ◆ Adapters Accommodate Any Combination
- ◆ Unmatched Flexibility



## Cruciform™ Drill Heads

Part #	Description	OAL	List
800RC040	1-1/2" DRILL HEAD	1-1/2"	\$210.25
800RC045	1-3/4" DRILL HEAD	1-1/2"	\$242.15
800RC052	2" DRILL HEAD	1-1/2"	\$275.86
800RC065	2-5/8" DRILL HEAD	1-1/2"	\$373.33
800RC080	3-1/8" DRILL HEAD	1-1/2"	\$421.06
800RC090	3-1/2" DRILL HEAD	1-1/2"	\$491.35
800RC100	4" DRILL HEAD	1-1/2"	\$526.43
800RC110	4-1/2" DRILL HEAD	1-1/2"	\$657.94
800RC125	5" DRILL HEAD	1-1/2"	\$753.36
800RC150	6" DRILL HEAD	1-1/2"	\$1104.26



**Replacement Coupler**  
5/8" - 11 X 2" OAL  
800RT001 List \$18.87

## Extensions

Part #	Description	List
800RE300	11" LONG EXTENSION	\$122.08
800RE350	12" LONG EVACUATION EXTENSION	\$125.56
800RE450	18" LONG EXTENSION	\$138.64



## Hard Body Spiral Flutes

Part #	Description	OAL	List
800RF145	1-1/2" FLUTE	4"	\$121.36
800RF145	1-3/4" FLUTE	4"	\$121.36
800RF152	2" FLUTE	4"	\$153.74
800RF165	2-5/8" FLUTE	4"	\$296.77
800RF180	3-1/8" FLUTE	4"	\$501.78
800RF180	3-1/2" FLUTE	4"	\$501.78



Same flute fits 1-1/2" & 1-3/4"

Same flute fits 3-1/8" & 3-1/2"

## Ratio Core Bits - INTERNAL THREAD

Part #	Description	OAL	List
800RK150	1-1/2" CORE BIT	3"	\$162.24
800RK200	2" CORE BIT	3"	\$169.61
800RK250	2-1/2" CORE BIT	3"	\$202.80
800RK300	3" CORE BIT	3"	\$235.95
800RK350	3-1/2" CORE BIT	3"	\$279.13
800RK400	4" CORE BIT	3"	\$342.16
800RK450	4-1/2" CORE BIT	3"	\$430.81
800RK500	5" CORE BIT	3"	\$463.36
800RK600	6" CORE BIT	3"	\$548.78



USE PILOT DRILL  
# 800RP255 ONLY!!!



All parts sold separately. Drilling through REBAR will cause damage to system.

- ◆ Rotary Hammer Drill
- ◆ Industrial Quality
- ◆ Special Tungsten Carbide Tip
- ◆ Copper / Silver Brazing
- ◆ Fastest Dust Removal
- ◆ Fastest Drilling Speeds
- ◆ Heat Treated Body
- ◆ Clean Round Holes
- ◆ Less Vibration
- ◆ Polished Finish
- ◆ ANSI Specification

- Brick
- Stone
- Masonry
- Aggregates



SOLD INDIVIDUALLY.  
1 PER TUBE.

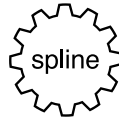

## Spline Drive Rotary Hammer Drills

Part #	Size	X	OAL	Drilling	Head	List
717SP1238	3/8"	X	10"	5"	REGULAR	\$37.80
717SP1638	3/8"	X	16"	11"	REGULAR	\$49.19
717SP1212	1/2"	X	10"	5"	REGULAR	\$39.84
717SP1612	1/2"	X	16"	11"	REGULAR	\$46.47
717SP2212	1/2"	X	22"	17"	REGULAR	\$60.39
717SP2812	1/2"	X	29"	24"	REGULAR	\$81.38
717SP3612	1/2"	X	36"	31"	REGULAR	\$111.08
717SP1291	9/16"	X	10"	5"	REGULAR	\$52.96
717SP1691	9/16"	X	16"	11"	REGULAR	\$66.91
717SP2291	9/16"	X	23"	17"	REGULAR	\$70.27
717SP2891	9/16"	X	29"	24"	REGULAR	\$107.98
717SP1258	5/8"	X	10"	5"	REGULAR	\$56.32
717SP1658	5/8"	X	16"	11"	REGULAR	\$69.75
717SP2258	5/8"	X	22"	17"	REGULAR	\$77.50
717SP3658	5/8"	X	36"	31"	REGULAR	\$143.47
717SP1211	11/16"	X	13"	8"	REGULAR	\$66.39
717SP1611	11/16"	X	16"	11"	REGULAR	\$78.79
717SP1234	3/4"	X	10"	5"	REGULAR	\$58.38
717SP1634	3/4"	X	16"	11"	REGULAR	\$65.88
717SP2234	3/4"	X	22"	17"	REGULAR	\$78.02
717SP3634	3/4"	X	36"	31"	REGULAR	\$151.39
717SP1678	7/8"	X	16"	11"	REGULAR	\$73.63
717SP2278	7/8"	X	22"	17"	REGULAR	\$85.28
717SP3678	7/8"	X	36"	31"	REGULAR	\$159.56
717SP1201	1"	X	13"	8"	REGULAR	\$76.21
717SP1601	1"	X	16"	11"	REGULAR	\$82.41
717SP2201	1"	X	22"	17"	REGULAR	\$96.88
717SP3601	1"	X	36"	31"	REGULAR	\$169.17
717SP1618	1-1/8"	X	16"	11"	REGULAR	\$79.40
717SP2218	1-1/8"	X	22"	17"	REGULAR	\$128.65
717SP1614	1-1/4"	X	16"	11"	REGULAR	\$109.02
717SP2214	1-1/4"	X	22"	17"	REGULAR	\$128.65
717SP3614	1-1/4"	X	36"	31"	REGULAR	\$189.34
717SP2213	1-3/8"	X	22"	17"	REGULAR	\$180.32
717SP6112	1-1/2"	X	16"	11"	REGULAR	\$149.32
717SP4112	1-1/2"	X	22"	17"	REGULAR	\$169.21
717SP3234	1-3/4"	X	22"	17"	REGULAR	\$257.82
717SP2202	2"	X	22"	17"	REGULAR	\$290.63

# X-CUTTER *DRILLS REINFORCED CONCRETE!*

## Spline Drive Rotary Hammer Drills

Part #	Size	X	OAL	Drilling	Head	List
7SPCR1058	5/8"	X	10"	6"	X-CUTTER	\$58.34
7SPCR1658	5/8"	X	16"	11"	X-CUTTER	\$67.78
7SPCR2258	5/8"	X	22"	17"	X-CUTTER	\$80.73
7SPCR2958	5/8"	X	29"	24"	X-CUTTER	\$111.96
7SPCR3658	5/8"	X	36"	31"	X-CUTTER	\$156.18
7SPCR1034	3/4"	X	10"	6"	X-CUTTER	\$67.46
7SPCR1634	3/4"	X	16"	11"	X-CUTTER	\$72.18
7SPCR2234	3/4"	X	22"	17"	X-CUTTER	\$85.46
7SPCR2934	3/4"	X	29"	24"	X-CUTTER	\$117.29
7SPCR3634	3/4"	X	36"	31"	X-CUTTER	\$162.06
7SPCR1678	7/8"	X	16"	11"	X-CUTTER	\$76.66
7SPCR2278	7/8"	X	22"	17"	X-CUTTER	\$94.43
7SPCR1601	1"	X	16"	11"	X-CUTTER	\$80.73
7SPCR2201	1"	X	22"	17"	X-CUTTER	\$101.63
7SPCR3601	1"	X	36"	31"	X-CUTTER	\$197.41
7SPCR1618	1-1/8"	X	16"	11"	X-CUTTER	\$101.35
7SPCR2218	1-1/8"	X	22"	17"	X-CUTTER	\$132.90
7SPCR1614	1-1/4"	X	16"	11"	X-CUTTER	\$111.96
7SPCR2214	1-1/4"	X	22"	17"	X-CUTTER	\$141.41
7SPCR3614	1-1/4"	X	36"	31"	X-CUTTER	\$214.10
7SPCR2238	1-3/8"	X	22"	17"	X-CUTTER	\$158.79
7SPCR2212	1-1/2"	X	22"	17"	X-CUTTER	\$182.69
7SPCR3423	1-3/4"	X	23"	18"	X-CUTTER	\$276.93

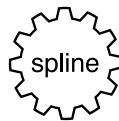

- ◆ Rotary Hammer Drill
- ◆ Industrial Quality
- ◆ 4-Cutter Head
- ◆ Special Tungsten Carbide Tip
- ◆ Copper / Silver Brazing
- ◆ Fastest Dust Removal
- ◆ Fastest Drilling Speeds
- ◆ Heat Treated Body
- ◆ Clean Round Holes
- ◆ Less Vibration
- ◆ Polished Finish
- ◆ ANSI Specification

- Reinforced Concrete
- Brick
- Stone
- Masonry
- Aggregates



SOLD INDIVIDUALLY  
1 PER TUBE.



- ◆ Rotary Hammer Drill
- ◆ Industrial Quality
- ◆ 4-Cutter Head
- ◆ Two Large Suction Holes
- ◆ Cleaner and Faster
- ◆ Copper / Silver Brazing
- ◆ Heat Treated Body
- ◆ Clean Round Holes
- ◆ Less Vibration
- ◆ Polished Finish
- ◆ ANSI Specification

- Concrete
- Brick
- Stone
- Masonry
- Aggregates



GERMANY



ANSI

SOLD INDIVIDUALLY.



### SDS-Plus Duster Drill Bit

Part #	Size	X	OAL	Drilling	Head	List
EXS-038	3/8"	X	10-1/2"	6"	DUSTER	\$85.42
EXS-716	7/16"	X	13"	8"	DUSTER	\$129.80
EXS-012	1/2"	X	13"	8"	DUSTER	\$133.74
EXS-916	9/16"	X	14"	9"	DUSTER	\$136.26
EXS-058	5/8"	X	14"	9"	DUSTER	\$143.41
EXS-034	3/4"	X	14"	9"	DUSTER	\$153.40
EXS-078	7/8"	X	14"	9"	DUSTER	\$241.81
EXS-1S	PLASTIC ADAPTER SDS-PLUS REPLACEMENT					\$34.03



### SDS-Max Duster Drill Bit

Part #	Size	X	OAL	Drilling	Head	List
EXM-120	1/2"	X	24"	15-1/2"	DUSTER	\$260.68
EXM-580	5/8"	X	24"	15-1/2"	DUSTER	\$279.03
EXM-340	3/4"	X	24"	15-1/2"	DUSTER	\$291.27
EXM-780	7/8"	X	24"	15-1/2"	DUSTER	\$302.36
EXM-100	1"	X	25"	17-1/2"	DUSTER	\$323.22
EXM-118	1-1/8"	X	35"	28"	DUSTER	\$489.91
EXM-138	1-3/8"	X	35"	28"	DUSTER	\$545.28
EXM-1M	PLASTIC ADAPTER SDS-MAX REPLACEMENT					\$35.42



Attach to Any HEPA Rated Vacuum to Meet OSHA Silica Dust Containment Standards.





### Economy Dust Pro (Up to 1")

Part #	Description	Qty.	List
DP-1	ECONOMY DUST PRO (PLASTIC)	1	\$7.63



- ◆ Attach to HEPA Vacuum and Stick to Drilling Surface
- ◆ No Drilling Dust
- ◆ No Need to Clean Holes Before Anchoring



JAPAN

SOLD INDIVIDUALLY.



Sold With One Metal Insert.



### Small Dust Pro (Up to 1")

Part #	Description	Qty.	List
DP-2	SMALL DUST PRO	1	\$96.83



Sold With One Rubber Insert.



### Large Dust Pro (Up to 3")

Part #	Description	Qty.	List
DP-3	LARGE DUST PRO	1	\$116.28



Metal Plate for DP-2



Rubber Plate for DP-3



### Replacement Inserts

Part #	Description	Qty.	List
DP-2-PL	METAL PLATE REPLACEMENT	1	\$17.67
DP-3-PL	RUBBER CUT OUT REPLACEMENT	1	\$21.75

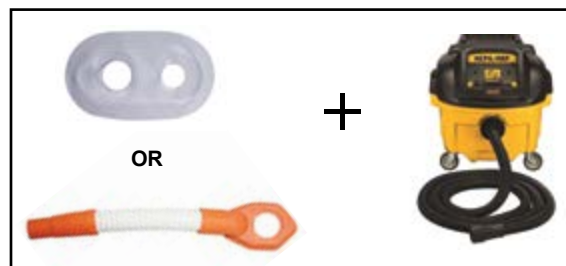

Attach to Any HEPA Rated Vacuum to Meet OSHA Silica Dust Containment Standards.



REBAR PUNCHER NOT SOLD WITH SHANK.



- ◆ Use in Rotary Hammer Action
- ◆ Industrial Quality
- ◆ Tungsten Carbide Teeth
- ◆ Twice the Speed
- ◆ Ratio System



SOLD INDIVIDUALLY. 1 PER TUBE.



### Rebar Puncher - ROTARY HAMMER ACTION

Part #	Size	OAL	RPM	List
RG-8	1/2"	9"	HAMMER ACTION	\$101.35
RG-9	9/16"	9"	HAMMER ACTION	\$101.35
RG-10	5/8"	9"	HAMMER ACTION	\$101.35
RG-11	11/16"	9"	HAMMER ACTION	\$102.94
RG-12	3/4"	9"	HAMMER ACTION	\$117.38
RG-14	7/8"	9"	HAMMER ACTION	\$152.22
RG-16	1"	9"	HAMMER ACTION	\$164.76
RG-18	1-1/8"	9"	HAMMER ACTION	\$179.30
RG-20	1-1/4"	9"	HAMMER ACTION	\$200.21



### Rebar Puncher Shanks

Part #	Description	OAL	List
RG-PLUS	SDS-PLUS	4"	\$39.42
RG-MAX	SDS-MAX	7-1/4"	\$78.14

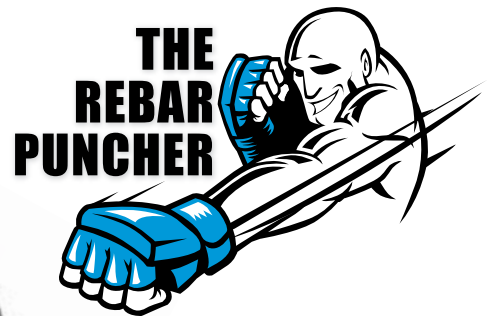

# 2X SPEED



### What to do when you encounter rebar:

- 1 **STOP DRILLING!!!** The sound of a rotary hammer or a carbide hammer drill bit hitting steel is much higher than when cutting concrete.
- 2 Remove the drill bit from the hole.
- 3 Mount a rebar cutter of the same diameter as the hole in an SDS-Plus Hammer Drill with the selector in the "rotary only" position.
- 4 Insert the rebar cutter into the hole and begin drilling at the suggested RPM speed only. Apply just enough pressure to grind away at the rebar. **Do Not Use Excessive Speed or Pressure on the Machine** - this will either damage or break the rebar cutter.
- 5 Once rebar is cut through, remove the rebar cutter from the hole and continue drilling with a rotary hammer or carbide hammer drill bit.

- Carbide cutters are brazed in place to keep Rebar Cutter from enlarging existing hole.

HEAD SIZES	THREAD
3/8" → 1-1/2"	1 pc.
1-3/4" → 2-1/2"	3/4"-10

**⚠ REMINDER:**

Rebar Cutters are problem solvers only. A 1/2" Rebar Cutter drilling through #6 (3/4") rebar dead center may result in 5 to 10 holes being drilled provided correct speed and pressure are utilized. It is not uncommon for only one piece of rebar to be cut per Rebar Cutter. Rebar Cutters *should not* be used for drilling concrete.

*Rebar Cutters are not warrantied for replacement or repair.*



### Rebar Cutter - SDS-PLUS SHANK

Part #	Size	OAL	RPM	List
RBS-6	3/8"	8"	850-1200	\$52.55
RBS-8	1/2"	12"	850-1200	\$55.00
RBS-9	9/16"	12"	850-1200	\$57.46
RBS-10	5/8"	12"	750-1000	\$69.74
RBS-11	11/16"	12"	750-1000	\$74.65
RBS-12	3/4"	12"	600-850	\$77.10
RBS-13	13/16"	12"	600-850	\$94.30
RBS-14	7/8"	12"	600-850	\$109.20
RBS-16	1"	12"	500-750	\$116.40
RBS-18	1-1/8"	12"	500-750	\$123.76
RBS-20	1-1/4"	12"	450-600	\$131.12
RBS-22	1-3/8"	12"	450-600	\$143.41
RBS-24	1-1/2"	12"	350-500	\$150.77
RBS-28	1-3/4"	12"	350-500	\$172.87
RBS-32	2"	12"	350-500	\$241.62
RBS-40	2-1/2"	12"	350-500	\$266.18



**Rotation Only!**

SOLD INDIVIDUALLY. 1 PER TUBE.



### Rebar Cutter - STRAIGHT SHANK

Part #	Size	OAL	RPM	List
RBC0838	3/8"	8"	850-1200	\$44.86
RBC1212	1/2"	12"	850-1200	\$53.29
RBC1916	9/16"	12"	850-1200	\$55.17
RBC1258	5/8"	12"	750-1000	\$63.34
RBC1116	11/16"	12"	750-1000	\$67.89
RBC1234	3/4"	12"	600-850	\$71.96
RBC1834	3/4"	18"	600-850	\$92.20
RBC1316	13/16"	12"	600-850	\$84.72
RBC1278	7/8"	12"	600-850	\$99.67
RBC1201	1"	12"	500-750	\$107.15
RBC1218	1-1/8"	12"	500-750	\$114.63
RBC1214	1-1/4"	12"	450-600	\$122.11
RBC1238	1-3/8"	12"	450-600	\$134.57
RBC1112	1-1/2"	12"	350-500	\$143.54
RBC1134	1-3/4"	12"	350-500	\$185.26
RBC1202	2"	12"	350-500	\$279.09
RBC1222	2-1/2"	12"	350-500	\$328.93



SOLD INDIVIDUALLY. 1 PER TUBE.





Bull Point



Flat Chisel



Scaling Chisel



Angled Chisel



Slotting Chisel



Bushing Tool



Ground Rod Driver



Asphalt Cutter



Seam Tool



Clay Spade



Floor Scraper



Gouge Chisel



Premium Bull Point



Premium Flat Chisel



**NOTE:** Spline Drive chisels have rounded hex shanks to work effectively in Spline Drive machines made with and without rotation / hammer only switches.

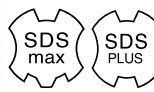

- ◆ Faster!
- ◆ Less Friction
- ◆ Less Jamming
- ◆ Self Sharpening



## Spline Drive Chisels

Part #	Size	Description	List
5000BP	12"	Bull Point	\$18.64
5005BP	18"	Bull Point	\$23.08
5010FC	1" x 12"	Flat Chisel	\$18.64
5015FC	1" x 18"	Flat Chisel	\$23.08
5020SC	1-1/2" x 12"	Scaling Chisel	\$27.58
5025SC	2" x 12"	Scaling Chisel	\$34.73
5030SC	3" x 12"	Scaling Chisel	\$38.37
5035AC	2" x 12"	Angled Chisel	\$55.84
5040SL	1-1/8" x 12"	Slotting Chisel	\$47.78
5045BT	1-7/8" x 9-7/8"	Bushing Tool	\$136.58
5050GR	7/8" x 10-1/2"	Ground Rod Driver	\$126.50
5055PH	3-1/2" x 16"	Asphalt Cutter	\$162.48
5060SM	1-1/8" x 12"	Seam Tool	\$45.57
5065CS	5-3/8" x 16"	Clay Spade	\$172.75
5070FS	6" x 25"	Floor Scraper	\$485.63

## SDS-MAX® Chisels

Part #	Size	Description	List
7000BP	12"	Bull Point	\$21.41
7005BP	18"	Bull Point	\$26.69
7010FC	1" x 12"	Flat Chisel	\$21.41
7015FC	1" x 18"	Flat Chisel	\$26.69
7020SC	1-1/2" x 12"	Scaling Chisel	\$33.23
7025SC	2" x 12"	Scaling Chisel	\$34.73
7028FC	2" x 16"	Scaling Chisel	\$45.50
7030SC	3" x 12"	Scaling Chisel	\$43.51
7035AC	2" x 12"	Angled Chisel	\$55.84
7040SL	1-1/8" x 12"	Slotting Chisel	\$46.39
7045BT	1-7/8" x 9-7/8"	Bushing Tool	\$137.96
7050GR	7/8" x 10-1/4"	Ground Rod Driver	\$125.22
7055PH	3-1/2" x 16"	Asphalt Cutter	\$167.61
7060SM	1-1/8" x 12"	Seam Tool	\$46.59
7065CS	5-3/8" x 16"	Clay Spade	\$171.47
7070FS	6" x 25"	Floor Scraper	\$485.63
7075GC	1" x 12"	Gouge Chisel	\$71.26
FS-6B		Replacement Blade (Floor Scraper)	\$22.20
FS-6NUT		Replacement Nuts & Bolts (Floor Scraper)	\$37.99

## Premium Chisels - 2X the Life

Part #	Size	Description	Shank	List
9004BP	16"	Bull Point	SDS-MAX	\$32.11
9014FC	1" x 16"	Flat Chisel	SDS-MAX	\$32.11
9100BP	10"	Bull Point	SDS-PLUS	\$22.50
9110FC	3/4" x 10"	Flat Chisel	SDS-PLUS	\$22.50

## SDS-PLUS Chisels

Part #	Size	Description	List
3100BP	10"	Bull Point	\$21.97
3110FC	3/4" x 10"	Flat Chisel	\$21.97
3115SC	1-1/2" x 10"	Scaling Chisel	\$40.84
3120GC	7/8" x 10"	Gouge Chisel	\$39.14
3125WC	3/8" x 7"	Wood Chisel	\$39.91
3130WC	1/2" x 7"	Wood Chisel	\$42.48
3140WC	3/4" x 7"	Wood Chisel	\$46.08
3150WC	1" x 7"	Wood Chisel	\$51.73
3175TC	3" x 6-1/2"	Tile Chisel	\$41.45



Gouge

Wood

Tile

## 3/4" HEX Chisels - Demolition Hammer

Part #	Size	Description	List
6010HEX	12"	3/4" Hex Bull Point	\$19.19
6015HEX	18"	3/4" Hex Bull Point	\$24.19
6020HEX	1" x 12"	3/4" Hex Flat Chisel	\$19.19
6025HEX	1" x 18"	3/4" Hex Flat Chisel	\$24.19
6030HEX	2" x 12"	3/4" Hex Scaling Chisel	\$35.80
6035HEX	3" x 12"	3/4" Hex Scaling Chisel	\$41.45
6040HEX	3-1/2" x 16"	3/4" Hex Asphalt Cutter	\$162.48
6045HEX	7/8" x 10-1/4"	3/4" Hex Ground Rod Dr.	\$139.09
6050HEX	1-7/8" x 9-7/8"	3/4" Hex Bushing Tool	\$140.12
6055HEX	5-3/8" x 16"	3/4" Hex Clay Spade	\$173.52
6060HEX	6" x 25"	3/4" Hex Floor Scraper	\$485.63

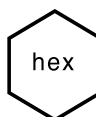

**Black & Decker®**  
5021K

**Bosch®**  
11301 - 11302 -  
11305

**Milwaukee®**  
5335

**Dewalt®**  
5021K,  
DW558

**Hitachi®**  
H55SC

**Makita®**  
HM1211B

## 1-1/8" HEX Chisels - Breaker Hammer

Part #	Size	Description	List
8020HBP	20"	1-1/8" Hex Bull Point	\$65.21
8030HFC	1-1/4" x 20"	1-1/8" Hex Flat Chisel	\$66.32
8040HSC	3" x 20"	1-1/8" Hex Scaling Chisel	\$95.74
8050HPH	5" x 17"	1-1/8" Hex Asphalt Cutter	\$215.06
8060HGR	1" x 15"	1-1/8" Hex Ground Rod Dr.	\$158.18
8070HCS	5-3/8" x 20"	1-1/8" Hex Clay Spade	\$219.23



**Black & Decker®**  
5027

**Bosch®**  
BRUTE 11304

**Milwaukee®**  
5338

**Kango®**  
2500

**Hitachi®**  
H65 - H85 -  
H905SB

**Makita®**  
HM1303B  
HM1500B  
HM1800

**Wacker®**  
EH27



1-1/8" HEX Shank Chisels come with Internal locks for Demolition Hammers and External Collars for Pneumatic Hammers.

## Tamping Plate & Shanks

Part #	Size	Description	List
510SPL	12"	Spline Tamping Shank	\$59.10
520MAX	12"	SDS-Max Tamping Shank	\$59.10
530HEX	15"	3/4" Hex Tamping Shank	\$61.89
550STP	5" Sq.	Tamping Plate	\$124.10



**Made In**



- ◆ Carbide Teeth
- ◆ Carbide Pilot
- ◆ Ejector Spring
- ◆ 2" Drilling Depth
- ◆ 3-Flat Shank
  
- Hard Plastic
- Stucco
- Clay Pipe
- Hardy Board
- Dry Lath & Plaster
- Wood with Nails
- Aluminum Siding
- Hard or Composite Plastic

**Also Available:**

- Extension Shanks
- Replacement Pilots
- Replacement Springs



**Composite Cutter**

Part #	Size	OAL	Shank	List
CHS-16	1"	6"	1/2"	\$178.78
CHS-18	1-1/8"	6"	1/2"	\$187.03
CHS-20	1-1/4"	6"	1/2"	\$191.28
CHS-22	1-3/8"	6"	1/2"	\$195.53
CHS-24	1-1/2"	6"	1/2"	\$204.02
CHS-26	1-5/8"	6"	1/2"	\$210.38
CHS-28	1-3/4"	6"	1/2"	\$216.77
CHS-32	2"	6"	1/2"	\$233.76
CHS-34	2-1/8"	6"	1/2"	\$244.41
CHS-36	2-1/4"	6"	1/2"	\$255.01
CHS-40	2-1/2"	6"	1/2"	\$267.80
CHS-48	3"	6"	1/2"	\$297.54
CHS-64	4"	6"	1/2"	\$365.52



**Shank Thread**

Diameter	Thread
3/4" & 7/8"	1/2"-13
1" → 4"	3/4"-10

**Made In**



- ◆ Carbide Teeth
- ◆ HSS Pilot
- ◆ Ejector Spring
- ◆ 2" Drilling Depth
- ◆ 3-Flat Shank
  
- Pipe
- Trench Duct
- Cellular Metal
- Ferrous Metals
- Non-Ferrous Metals
- Ductile Iron Pipe

**Also Available:**

- Extension Shanks
- Replacement Pilots
- Replacement Springs



**Interrupter**

Part #	Size	OAL	Shank	List
IC-12	3/4"	6"	3/8"	\$189.13
IC-14	7/8"	6"	3/8"	\$191.28
IC-16	1"	6"	1/2"	\$197.63
IC-18	1-1/8"	6"	1/2"	\$208.27
IC-20	1-1/4"	6"	1/2"	\$218.91
IC-22	1-3/8"	6"	1/2"	\$223.16
IC-24	1-1/2"	6"	1/2"	\$231.66
IC-28	1-3/4"	6"	1/2"	\$240.16
IC-32	2"	6"	1/2"	\$267.80
IC-36	2-1/4"	6"	1/2"	\$278.40
IC-38	2-3/8"	6"	1/2"	\$289.04
IC-40	2-1/2"	6"	1/2"	\$297.54
IC-44	2-3/4"	6"	1/2"	\$323.03
IC-48	3"	6"	1/2"	\$350.67
IC-52	3-1/4"	6"	1/2"	\$382.55
IC-56	3-1/2"	6"	1/2"	\$408.05
IC-60	3-3/4"	6"	1/2"	\$431.43
IC-64	4"	6"	1/2"	\$439.93

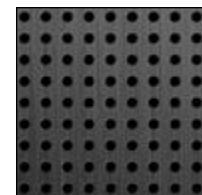
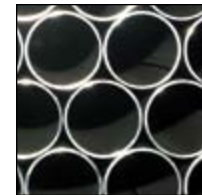



### Superdry™ Center Pin

Part #	Description	List
DRY-CP1	CENTER PIN - FOR SUPERDRY DIAMOND	\$120.00

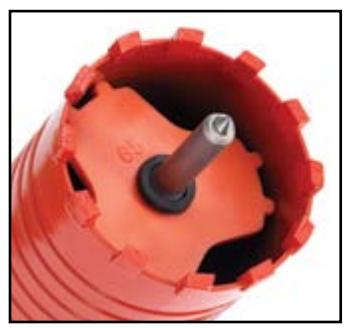

### Superdry™ Diamond Core Bit

Part #	Size	# Teeth	Drilling	Shank	List
DRY-25C	1"	6	6"	#1	\$474.54
DRY-29C	1-1/8"	7	6"	#1	\$474.54
DRY-32C	1-1/4"	8	6"	#1	\$474.54
DRY-35C	1-3/8"	8	6"	#1	\$474.54
DRY-38C	1-1/2"	9	6"	#1	\$474.54
DRY-45C	1-3/4"	9	6"	#1	\$474.54
DRY-50C	2"	10	6"	#2	\$496.33
DRY-55C	2-1/8"	11	6"	#2	\$496.33
DRY-60C	2-3/8"	12	6"	#2	\$518.21
DRY-65C	2-9/16"	12	6"	#2	\$545.46
DRY-70C	2-3/4"	13	6"	#2	\$578.21
DRY-75C	2-7/8"	15	6"	#2	\$638.21
DRY-80C	3-1/8"	16	6"	#2	\$698.21
DRY-90C	3-1/2"	16	6"	#2	\$790.92
DRY-95C	3-3/4"	16	6"	#2	\$872.75
DRY-100C	3-7/8"	17	6"	#2	\$927.25
DRY-105C	4-1/8"	17	6"	#2	\$981.79
DRY-120C	4-3/4"	17	6"	#2	\$1145.46
DRY-130C	5-1/8"	18	6"	#2	\$1172.75
DRY-155C	6"	22	6"	#2	\$1445.46
DRY-165C	6-1/2"	24	6"	#2	\$1500.00
DRY-180C	7"	25	6"	#2	\$1612.33
DRY-210C	8-1/4"	30	6"	#2	\$1936.33

### Rotation Only!

- ◆ CLIC System
- ◆ Diamond Teeth
- ◆ Capable of Dry Drilling in Reinforced Concrete
- ◆ Carbide Tipped Center Pin
- ◆ Clean Round Holes
- ◆ Made in Japan



- Reinforced Concrete
- Concrete
- Mortar
- Hume (Culvert) Pipe
- Clay Pipe
- PVC Pipe



Replacement Guide Plates Available.



### Superdry™ SDS-Plus Extension

Part #	Size	Shank	List
DRY-S1-8	5" EXTENSION (FOR 1" THRU 1-3/4")	#1	\$99.25
DRY-S1-12	8" EXTENSION (FOR 1" THRU 1-3/4")	#1	\$120.00
DRY-S2-8	5" EXTENSION (FOR 2" THRU 8-1/4")	#2	\$178.46
DRY-S2-12	8" EXTENSION (FOR 2" THRU 8-1/4")	#2	\$213.79





FOR DRILLING  
LARGER DIAMETER  
HOLES IN  
CONCRETE

### Diamond Core Bits - Economy

- ◆ Industrial Quality
- ◆ Quality Diamond Teeth
- ◆ 14" Cutting Depth
- ◆ Use With Water
- ➔ Reinforced Concrete
- ➔ Concrete
- ➔ Brick
- ➔ Stone
- ➔ Masonry
- ➔ Aggregates



USE WATER

Part #	Size	X	OAL	# Teeth	Thread	List
DC-01	1"	X	15-3/4"	3	5/8" x 11	\$62.83
DC-02	1-1/4"	X	15-3/4"	4	5/8" x 11	\$78.56
DC-03	1-3/4"	X	15-3/4"	4	5/8" x 11	\$81.72
DC-04	2"	X	15-3/4"	4	1-1/4" x 7	\$87.00
DC-05	2-1/2"	X	15-3/4"	6	1-1/4" x 7	\$103.72
DC-06	2-3/4"	X	15-3/4"	6	1-1/4" x 7	\$112.06
DC-07	3"	X	15-3/4"	6	1-1/4" x 7	\$114.67
DC-75	3-1/2"	X	15-3/4"	6	1-1/4" x 7	\$124.22
DC-08	4"	X	15-3/4"	8	1-1/4" x 7	\$133.00
DC-09	4-3/8"	X	15-3/4"	9	1-1/4" x 7	\$158.17
DC-95	4-1/2"	X	15-3/4"	9	1-1/4" x 7	\$171.28
DC-10	4-3/4"	X	15-3/4"	10	1-1/4" x 7	\$186.50
DC-11	5"	X	15-3/4"	10	1-1/4" x 7	\$193.11
DC-12	6"	X	15-3/4"	12	1-1/4" x 7	\$210.56
DC-20	8"	X	15-3/4"	16	1-1/4" x 7	\$334.17

SOLD INDIVIDUALLY.  
1 PER BOX.

### 10mm Tall Segments



FOR DRILLING  
LARGER DIAMETER  
HOLES IN  
CONCRETE

### Diamond Core Bits - Premium

Part #	Size	X	OAL	# Teeth	Thread	List
KDX-04	2"	X	15-3/4"	5	1-1/4" x 7	\$140.00
KDX-05	2-1/2"	X	15-3/4"	6	1-1/4" x 7	\$151.67
KDX-07	3"	X	15-3/4"	6	1-1/4" x 7	\$186.67
KDX-08	4"	X	15-3/4"	8	1-1/4" x 7	\$244.44
KDX-11	5"	X	15-3/4"	10	1-1/4" x 7	\$330.67
KDX-12	6"	X	15-3/4"	12	1-1/4" x 7	\$380.44
KDX-20	8"	X	15-3/4"	16	1-1/4" x 7	\$483.00

Step Down Adapter



Hilti BI+ Adapter



Extension



### Diamond Core Adapters / Extensions

Part #	Description	List
ADA001	ADAPTER STEP DOWN (1-1/4"-7 TO 5/8"-11)	\$76.40
HILA001	HILTI BI+ TO 5/8"-11 ADAPTER	\$55.10
HILA002	HILTI BI+ TO 1-1/4"-7 ADAPTER	\$84.58
DCEXT01	6" DIAMOND CORE BIT EXTENSION (5/8"-11)	\$130.61
DCEXT02	12" DIAMOND CORE BIT EXTENSION (5/8"-11)	\$180.19
DCEXT03	6" DIAMOND CORE BIT EXTENSION (1-1/4"-7)	\$178.58
DCEXT04	12" DIAMOND CORE BIT EXTENSION (1-1/4"-7)	\$194.03



- ◆ Industrial Quality
- ◆ Quality Premium Diamond Teeth
- ◆ 14" Cutting Depth
- ◆ Use With Water

- ➔ Reinforced Concrete
- ➔ Concrete
- ➔ Brick
- ➔ Stone
- ➔ Masonry
- ➔ Aggregates



USE WATER

SOLD INDIVIDUALLY.  
1 PER BOX.

**2X HOLES**

10mm Tall Segments





- ◆ Industrial Quality
- ◆ Quality Premium Diamond Teeth
- ◆ 9" Cutting Depth
- ◆ Dry Drilling
- ◆ 8mm Segments
- ◆ Attack Tooth Geometry

- Concrete
- Cement Block
- Brick
- Masonry
- Pavers



### Diamond Core Bits - Dry Drilling

Part #	Size	X	OAL	# Teeth	Thread	List
DRX-02	1-1/4"	X	10-3/4"	3	5/8" x 11	\$91.67
DRX-03	1-1/2"	X	10-3/4"	3	5/8" x 11	\$108.33
DRX-04	2"	X	10-3/4"	4	5/8" x 11	\$152.78
DRX-05	2-1/2"	X	10-3/4"	3	5/8" x 11	\$188.89
DRX-07	3"	X	10-3/4"	4	5/8" x 11	\$241.67

FOR USE WITH A 7" ANGLE GRINDER



1.



2.



3.



## Diamond Cutting Wheels

- ◆ Industrial Quality
- ◆ For Dry & Wet Use
- ◆ Individually Blister Carded

- Brick
- Stone
- Masonry
- Aggregates



Diamond Cutting Wheels are great for general contractor work. Each wheel comes with interchangeable adapters for use in virtually all hand-held saws and angle grinders.

### 4" TUCK POINT DIAMOND CUTTING WHEEL

**Part # TPS40**

**List \$66.64**

- DRY TYPE
- DIAMETER: 4" ± 0.70MM
- TEETH THICKNESS: 0.25" (-0.00/+0.20MM)
- 28 CRMO Body / LASER WELDED BLADE
- 20MM ROUND ARBOR W/ 5/8" BUSHING ADAPTER (SOLID BRASS)
- 20-25% CONCENTRATION OF DIAMOND GRAIN
- 13,700 RPM MAXIMUM



### 4-1/2" TUCK POINT DIAMOND CUTTING WHEEL

**Part # TPS45**

**List \$77.75**

- DRY TYPE
- DIAMETER: 4-1/2" ± 0.70MM
- TEETH THICKNESS: 0.25" (-0.00/+0.20MM)
- 28 CRMO Body / LASER WELDED BLADE
- 20MM ROUND ARBOR W/ 5/8" BUSHING ADAPTER (SOLID BRASS)
- 20-25% CONCENTRATION OF DIAMOND GRAIN
- 13,700 RPM MAXIMUM



### 4" CONTINUOUS RIM DIAMOND CUTTING WHEEL

**Part # DCR40**

**List \$14.58**

- DRY & WET TYPE
- DIAMETER: 4" ± 0.70MM
- TEETH THICKNESS: 0.08" (-0.00/+0.20MM)
- 65MN BODY
- 7/8" ROUND ARBOR W/ 20MM & 5/8" BUSHING ADAPTER (SOLID BRASS)
- 20-25% CONCENTRATION OF DIAMOND GRAIN
- 13,700 RPM MAXIMUM







**4-1/2" CONTINUOUS RIM DIAMOND CUTTING WHEEL**

**Part # DCR45**

**List \$17.36**

- DRY & WET TYPE
- DIAMETER: 4-1/2" ± 0.70MM
- TEETH THICKNESS: 0.08" (-0.00/+0.20MM)
- 65MN BODY
- 7/8" ROUND ARBOR W/ 20MM & 5/8" BUSHING ADAPTER (SOLID BRASS)
- 20-25% CONCENTRATION OF DIAMOND GRAIN
- 13,300 RPM MAXIMUM



**7" CONTINUOUS RIM DIAMOND CUTTING WHEEL**

**Part # DCR70**

**List \$39.58**

- DRY & WET TYPE
- DIAMETER: 7" ± 0.70MM
- TEETH THICKNESS: 0.08" (-0.00/+0.20MM)
- 65MN BODY
- 7/8" ROUND ARBOR W/ 20MM & 5/8" BUSHING ADAPTER (SOLID BRASS)
- 20-25% CONCENTRATION OF DIAMOND GRAIN
- 8,400 RPM MAXIMUM

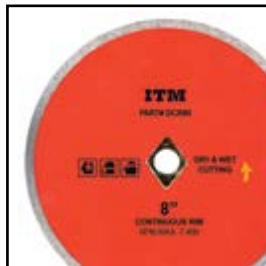

**8" CONTINUOUS RIM DIAMOND CUTTING WHEEL**

**Part # DCR80**

**List \$42.75**

- DRY & WET TYPE
- DIAMETER: 8" ± 0.70MM
- TEETH THICKNESS: 0.1" (-0.00/+0.20MM)
- 65MN BODY
- 7/8" ROUND ARBOR W/ 20MM & 5/8" RHOMBIC BUSHING ADAPTER (SOLID BRASS)
- 20-25% CONCENTRATION OF DIAMOND GRAIN
- 7,400 RPM MAXIMUM



**4" TURBO DIAMOND CUTTING WHEEL**

**Part # DTU40**

**List \$16.06**

- DRY & WET TYPE
- DIAMETER: 4" ± 0.70MM
- TEETH THICKNESS: 0.08" (-0.00/+0.20MM)
- 65MN BODY
- 7/8" ROUND ARBOR W/ 20MM & 5/8" BUSHING ADAPTER (SOLID BRASS)
- 20-25% CONCENTRATION OF DIAMOND GRAIN
- 13,700 RPM MAXIMUM



**4-1/2" TURBO DIAMOND CUTTING WHEEL**

**Part # DTU45**

**List \$20.18**

- DRY & WET TYPE
- DIAMETER: 4-1/2" ± 0.70MM
- TEETH THICKNESS: 0.08" (-0.00/+0.20MM)
- 65MN BODY
- 7/8" ROUND ARBOR W/ 20MM & 5/8" BUSHING ADAPTER (SOLID BRASS)
- 20-25% CONCENTRATION OF DIAMOND GRAIN
- 13,300 RPM MAXIMUM

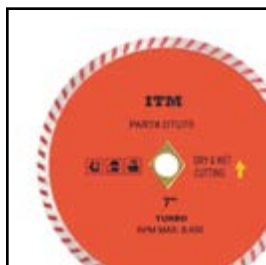

**7" TURBO DIAMOND CUTTING WHEEL**

**Part # DTU70**

**List \$46.76**

- DRY & WET TYPE
- DIAMETER: 7" ± 0.70MM
- TEETH THICKNESS: 0.08" (-0.00/+0.20MM)
- 65MN BODY
- 7/8" ROUND ARBOR W/ 20MM & 5/8" BUSHING ADAPTER (SOLID BRASS)
- 20-25% CONCENTRATION OF DIAMOND GRAIN
- 8,400 RPM MAXIMUM

8" TURBO DIAMOND CUTTING WHEEL	
<b>Part # DTU80</b>  <b>List \$50.50</b>	<ul style="list-style-type: none"> <li>• DRY &amp; WET TYPE</li> <li>• DIAMETER: 8" ± 0.70MM</li> <li>• TEETH THICKNESS: 0.1" (-0.00/+0.20MM)</li> <li>• 65MN BODY</li> <li>• 7/8" ROUND ARBOR W/ 20MM &amp; 5/8" RHOMBIC BUSHING ADAPTER (SOLID BRASS)</li> <li>• 20-25% CONCENTRATION OF DIAMOND GRAIN</li> <li>• 7,400 RPM MAXIMUM</li> </ul>

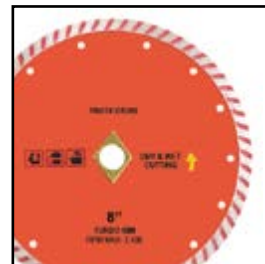

4" SEGMENTED DIAMOND CUTTING WHEEL	
<b>Part # DCS40</b>  <b>List \$14.58</b>	<ul style="list-style-type: none"> <li>• DRY TYPE</li> <li>• DIAMETER: 4" ± 0.70MM</li> <li>• TEETH THICKNESS: 0.08" (-0.00/+0.20MM)</li> <li>• 65MN BODY</li> <li>• 7/8" ROUND ARBOR W/ 20MM &amp; 5/8" BUSHING ADAPTER (SOLID BRASS)</li> <li>• 20-25% CONCENTRATION OF DIAMOND GRAIN</li> <li>• 13,700 RPM MAXIMUM</li> </ul>



4-1/2" SEGMENTED DIAMOND CUTTING WHEEL	
<b>Part # DCS45</b>  <b>List \$17.36</b>	<ul style="list-style-type: none"> <li>• DRY TYPE</li> <li>• DIAMETER: 4-1/2" ± 0.70MM</li> <li>• TEETH THICKNESS: 0.08" (-0.00/+0.20MM)</li> <li>• 65MN BODY</li> <li>• 7/8" ROUND ARBOR W/ 20MM &amp; 5/8" BUSHING ADAPTER (SOLID BRASS)</li> <li>• 20-25% CONCENTRATION OF DIAMOND GRAIN</li> <li>• 13,300 RPM MAXIMUM</li> </ul>



7" SEGMENTED DIAMOND CUTTING WHEEL	
<b>Part # DCS70</b>  <b>List \$39.58</b>	<ul style="list-style-type: none"> <li>• DRY TYPE</li> <li>• DIAMETER: 7" ± 0.70MM</li> <li>• TEETH THICKNESS: 0.08" (-0.00/+0.20MM)</li> <li>• 65MN BODY</li> <li>• 7/8" ROUND ARBOR W/ 20MM &amp; 5/8" BUSHING ADAPTER (SOLID BRASS)</li> <li>• 20-25% CONCENTRATION OF DIAMOND GRAIN</li> <li>• 8,400 RPM MAXIMUM</li> </ul>



12" SEGMENTED DIAMOND CUTTING WHEEL	
<b>Part # DCS120</b> <b>List \$76.40</b>	<ul style="list-style-type: none"> <li>• DRY TYPE</li> <li>• DIAMETER: 12"</li> <li>• TEETH THICKNESS: 0.1" (-0.05/+0.20MM)</li> <li>• TEETH (HIGH): 0.256" (-0.20/+0.70mm)</li> <li>• 65MN BODY</li> <li>• 1" ROUND ARBOR W/ 20MM &amp; 7/8" BUSHING ADAPTER (SOLID BRASS)</li> <li>• 20-25% CONCENTRATION OF DIAMOND GRAIN</li> <li>• 5,000 RPM MAXIMUM</li> </ul>
 <b>Part # 2DD191S</b> <b>14MM Brass Ring for 1" Arbor Diamond Wheels</b> <b>List \$3.05</b>	

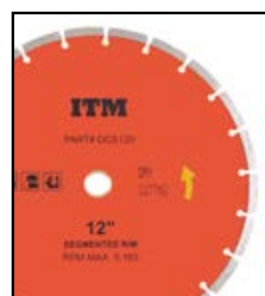

14" SEGMENTED DIAMOND CUTTING WHEEL	
<b>Part # DCS140</b> <b>List \$103.32</b>	<ul style="list-style-type: none"> <li>• DRY TYPE</li> <li>• DIAMETER: 14"</li> <li>• TEETH THICKNESS: 0.12" (-0.05/+0.20MM)</li> <li>• TEETH (HIGH): 0.315" (-0.20/+0.70mm)</li> <li>• 65MN BODY</li> <li>• 1" ROUND ARBOR W/ 20MM &amp; 7/8" BUSHING ADAPTER (SOLID BRASS)</li> <li>• 20-25% CONCENTRATION OF DIAMOND GRAIN</li> <li>• 4,300 RPM MAXIMUM</li> </ul>
 <b>Part # 2DD191S</b> <b>14MM Brass Ring for 1" Arbor Diamond Wheels</b> <b>List \$3.05</b>	

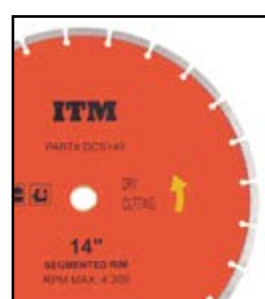



## Phillips

PHILLIPS POINT #	SHEET METAL SCREWS	WOOD SCREWS		MACHINE SCREWS		
	FLAT, ROUND, OVAL STOVE BINDING	FLAT, OVAL	ROUND	FLAT, OVAL BINDING	ROUND, FILLISTER	TRUSS, BRAZIER BUTTON
0	0, 1	0, 1	0, 1	0, 1	0, 1	0, 1
1	2, 3, 4	2, 3, 4	2, 3, 4	2, 3, 4	2, 3, 4	2, 3, 4, 5
2	5, 6, 7, 8, 10	5, 6, 7, 8, 9	5, 6, 7, 8, 9, 10	5, 6, 8, 10	5, 6, 8, 10	6, 8, 10
3	12, 14	10, 12, 14, 16	12, 14, 16	12, 1/4"	12, 1/4", 5/16"	12, 1/4"

## Slotted

SLOTTED POINT #	SCREW SIZE	SLOT SCREW WIDTH		THREAD DIA.	MAXIMUM HEAD DIAMETER					
		MIN.	MAX.		FLAT or OVAL HEAD	ROUND HEAD	FILLISTER HEAD	BINDING HEAD	PAN HEAD	TRUSS HEAD
4-5	3	.027	.035	.099	.199	.187	.161	.208	.193	.226
4-5	4	.031	.039	.112	.225	.211	.183	.235	.219	.257
6-8	5	.035	.043	.125	.252	.236	.205	.263	.245	.289
8-10	6	.039	.048	.138	.279	.260	.226	.290	.270	.321
10-12	8	.045	.054	.164	.332	.309	.270	.344	.322	.384

## Square

SQUARE POINT #	TAPPING SCREWS	WOOD SCREWS	MACHINE SCREWS
0	3, 4	3, 4	3, 4
1	5, 6, 7	5, 6, 7	5, 6
2	8, 10	8, 9, 10	8, 10
3	12, 14	12, 14	12, 14

## Star **FOR TORX® SCREWS.**

SCREW SIZE	THREAD DIA.	INTERNAL TORX WASHER HEAD	PAN HEAD	FLAT HEAD	HEX HEAD	TRUSS HEAD	FILLISTER HEAD	OVAL HEAD	SOCKET HEAD CAP	SOCKET SET SCREW
2	.086	T7	T7	T6						
3	.099	T8	T8	T7						
4	.112	T9	T9	T8	T9		T9		T10	T6
5	.125	T10	T10	T9	T10		T10	T10	T10	T7
6	.138	T15	T15	T10	T15	T10	T15	T15	T15	T7
8	.164	T20	T20	T15	T20	T15	T20	T20	T25	T8
10	.190	T25	T25	T20	T25	T20	T25	T25	T27	T10
12	.216	T27	T27	T25	T27	T25	T27	T27	T27	T10
1/4"	.250	T30	T30	T27	T30	T27	T30	T30	T30	T20
5/16"	.312			T40	T40	T40	T340	T40	T45	T27
3/8"	.375		T45	T40	T45	T45	T45	T45	T50	T30
7/16"	.437		T50	T50		T45	T50	T50	T55	T40
1/2"	.500		T55	T50		T50	T55	T50	T55	T45



**STAINLESS STEEL  
SHAFT**

**Made In**



**1/4" Drive & 5/16" Drive Magnetic Screwdrivers  
With Insert Bit Storage Handles. BITS NOT INCLUDED.**

Part #	Drive	Description	List
HH-08-001	1/4"	8" MAGNETIC STORAGE HANDLE	\$18.15
HH-08-002	5/16"	8" MAGNETIC STORAGE HANDLE	\$18.75



**Insert Bit Countertop Dispenser**

Part #	Type	Qty.	List
BITDIS	EMPTY DISPLAY	1	\$275.00

- ◆ Sold Empty
- ◆ Make Your Own Assortment
- ◆ Display Made In Canada



**KEEP YOUR INSERT BITS AND NUT SETTERS SAFE AND ORGANIZED.**





### Phillips® Insert Bits - 1/4" Hex Shank

Part #	Size	OAL	Type	Qty.	List
T3-025-00	#0 X 1"		PHILLIPS INSERT	25	\$0.75
T3-025-01	#1 X 1"		PHILLIPS INSERT	25	\$0.50
T3-025-02	#2 X 1"		PHILLIPS INSERT	25	\$0.45
T3-025-03	#3 X 1"		PHILLIPS INSERT	25	\$0.45
T3-025-04	#4 X 1"		PHILLIPS INSERT	25	\$3.25



Reduced Body

### Phillips® Drywall Bits - 1/4" Hex Shank

Part #	Size	OAL	Type	Qty.	List
T3-025-1W	#1 X 1"		PHILLIPS DRYWALL	25	\$0.50
T3-025-2W	#2 X 1"		PHILLIPS DRYWALL	25	\$0.50



### Phillips® Insert Bits - 5/16" Hex Shank

Part #	Size	OAL	Type	Qty.	List
T3-032-01	#1 X 1-1/4"		PHILLIPS INSERT	25	\$0.95
T3-032-02	#2 X 1-1/4"		PHILLIPS INSERT	25	\$0.95
T3-032-03	#3 X 1-1/4"		PHILLIPS INSERT	25	\$0.95



### Phillips® Stopper - 1/4" Hex Shank

Part #	Size	OAL	Type	Qty.	List
SP-025-2P	#2 X 1"		PHILLIPS STOPPER	25	\$1.75



### Phillips® ACR® Insert Bits - 1/4" Hex

Part #	Size	OAL	Type	Qty.	List
ACR-025-01	#1 X 1"		PHILLIPS ACR INSERT	25	\$0.55
ACR-025-02	#2 X 1"		PHILLIPS ACR INSERT	25	\$0.55
ACR-025-03	#3 X 1"		PHILLIPS ACR INSERT	25	\$0.55



### Phillips® Power Bits - 1/4" Hex Shank

Part #	Size	OAL	Type	Qty.	List
T3-050-01	#1 X 2"		PHILLIPS POWER	25	\$0.75
T3-070-01	#1 X 2-3/4"		PHILLIPS POWER	25	\$1.25
T3-075-01	#1 X 3"		PHILLIPS POWER	25	\$1.35
T3-090-01	#1 X 3-1/2"		PHILLIPS POWER	25	\$1.55
T3-100-01	#1 X 4"		PHILLIPS POWER	25	\$1.85
T3-125-01	#1 X 5"		PHILLIPS POWER	25	\$2.55
T3-150-01	#1 X 6"		PHILLIPS POWER	25	\$3.25
T3-050-02	#2 X 2"		PHILLIPS POWER	25	\$0.75
T3-070-02	#2 X 2-3/4"		PHILLIPS POWER	25	\$1.25
T3-075-02	#2 X 3"		PHILLIPS POWER	25	\$1.35
T3-090-02	#2 X 3-1/2"		PHILLIPS POWER	25	\$1.55
T3-100-02	#2 X 4"		PHILLIPS POWER	25	\$1.85
T3-125-02	#2 X 5"		PHILLIPS POWER	25	\$2.55
T3-150-02	#2 X 6"		PHILLIPS POWER	25	\$3.25
T3-050-03	#3 X 2"		PHILLIPS POWER	25	\$0.75
T3-070-03	#3 X 2-3/4"		PHILLIPS POWER	25	\$1.25
T3-075-03	#3 X 3"		PHILLIPS POWER	25	\$1.35
T3-090-03	#3 X 3-1/2"		PHILLIPS POWER	25	\$1.55
T3-100-03	#3 X 4"		PHILLIPS POWER	25	\$1.85
T3-125-03	#3 X 5"		PHILLIPS POWER	25	\$2.55
T3-150-03	#3 X 6"		PHILLIPS POWER	25	\$3.25



Reduced Body

### Phillips® Drywall Bits

Part #	Size	OAL	Type	Qty.	List
T3-050-2W	#2 X 2"		PHILLIPS DRYWALL	25	\$0.85
T3-070-2W	#2 X 2-3/4"		PHILLIPS DRYWALL	25	\$1.35
T3-090-2W	#2 X 3-1/2"		PHILLIPS DRYWALL	25	\$2.15



### Phillips® ACR® Power Bits - 1/4" Hex

Part #	Size	OAL	Type	Qty.	List
ACR-050-01	#1 X 2"		PHILLIPS ACR POWER	25	\$0.95
ACR-050-02	#2 X 2"		PHILLIPS ACR POWER	25	\$0.95
ACR-050-03	#3 X 2"		PHILLIPS ACR POWER	25	\$0.95



For Torx® Screws

### Star Insert Bits - 1/4" Hex Shank

Part #	Size	OAL	Type	Qty.	List
TX-025-06	T6 X	1"	STAR INSERT	25	\$0.65
TX-025-07	T7 X	1"	STAR INSERT	25	\$0.65
TX-025-08	T8 X	1"	STAR INSERT	25	\$0.65
TX-025-09	T9 X	1"	STAR INSERT	25	\$0.65
TX-025-10	T10 X	1"	STAR INSERT	25	\$0.65
TX-025-15	T15 X	1"	STAR INSERT	25	\$0.65
TX-025-20	T20 X	1"	STAR INSERT	25	\$0.65
TX-025-25	T25 X	1"	STAR INSERT	25	\$0.65
TX-025-27	T27 X	1"	STAR INSERT	25	\$0.65
TX-025-30	T30 X	1"	STAR INSERT	25	\$0.65
TX-025-40	T40 X	1"	STAR INSERT	25	\$0.65



### Square Insert Bits - 1/4" Hex Shank

Part #	Size	OAL	Type	Qty.	List
T3-R25-00	#0 X	1"	SQUARE INSERT	25	\$0.65
T3-R25-01	#1 X	1"	SQUARE INSERT	25	\$0.58
T3-R25-02	#2 X	1"	SQUARE INSERT	25	\$0.58
T3-R25-03	#3 X	1"	SQUARE INSERT	25	\$0.58



For Torx® Screws

### Star Power Bits - 5/16" Hex Shank

Part #	Size	OAL	Type	Qty.	List
TX-032-30	T30 X	1-1/4"	STAR POWER	25	\$1.55
TX-032-40	T40 X	1-1/4"	STAR POWER	25	\$1.55
TX-032-45	T45 X	1-1/4"	STAR POWER	25	\$1.55
TX-032-50	T50 X	1-1/4"	STAR POWER	25	\$1.55
TX-032-55	T55 X	1-1/4"	STAR POWER	25	\$1.55



### Square Power Bits - 1/4" Hex Shank

Part #	Size	OAL	Type	Qty.	List
T3-R50-01	#1 X	2"	SQUARE POWER	25	\$1.45
T3-R70-01	#1 X	2-3/4"	SQUARE POWER	25	\$1.60
T3-R75-01	#1 X	3"	SQUARE POWER	25	\$1.85
T3-R90-01	#1 X	3-1/2"	SQUARE POWER	25	\$2.05
T3-R10-01	#1 X	4"	SQUARE POWER	25	\$2.15
T3-R12-01	#1 X	5"	SQUARE POWER	25	\$2.75
T3-R15-01	#1 X	6"	SQUARE POWER	25	\$3.75
T3-R50-02	#2 X	2"	SQUARE POWER	25	\$1.45
T3-R70-02	#2 X	2-3/4"	SQUARE POWER	25	\$1.60
T3-R75-02	#2 X	3"	SQUARE POWER	25	\$1.85
T3-R90-02	#2 X	3-1/2"	SQUARE POWER	25	\$2.05
T3-R10-02	#2 X	4"	SQUARE POWER	25	\$2.15
T3-R12-02	#2 X	5"	SQUARE POWER	25	\$2.75
T3-R15-02	#2 X	6"	SQUARE POWER	25	\$3.75
T3-R50-03	#3 X	2"	SQUARE POWER	25	\$1.45
T3-R70-03	#3 X	2-3/4"	SQUARE POWER	25	\$1.60
T3-R75-03	#3 X	3"	SQUARE POWER	25	\$1.85
T3-R90-03	#3 X	3-1/2"	SQUARE POWER	25	\$2.05
T3-R10-03	#3 X	4"	SQUARE POWER	25	\$2.15
T3-R12-03	#3 X	5"	SQUARE POWER	25	\$2.75
T3-R15-03	#3 X	6"	SQUARE POWER	25	\$3.75



For Torx® Screws

### Star Power Bits - 1/4" Hex Shank

Part #	Size	OAL	Type	Qty.	List
TX-050-10	T10 X	2"	STAR POWER	25	\$0.85
TX-150-10	T10 X	6"	STAR POWER	25	\$7.45
TX-050-15	T15 X	2"	STAR POWER	25	\$0.85
TX-150-15	T15 X	6"	STAR POWER	25	\$7.45
TX-050-20	T20 X	2"	STAR POWER	25	\$0.85
TX-150-20	T20 X	6"	STAR POWER	25	\$7.45
TX-050-25	T25 X	2"	STAR POWER	25	\$0.85
TX-150-25	T25 X	6"	STAR POWER	25	\$7.45
TX-050-27	T27 X	2"	STAR POWER	25	\$0.85
TX-150-27	T27 X	6"	STAR POWER	25	\$7.45
TX-050-30	T30 X	2"	STAR POWER	25	\$0.85
TX-150-30	T30 X	6"	STAR POWER	25	\$7.45
TX-050-40	T40 X	2"	STAR POWER	25	\$0.85
TX-150-40	T40 X	6"	STAR POWER	25	\$7.45



- ◆ S2 Modified Steel
- ◆ Rc. 58-62 Heat Treated
- ◆ German Grade Steel



**Pozidriv® Insert Bits - 1/4" Hex Shank**

Part #	Size	OAL	Type	Qty.	List
PZ-025-01	#1 X 1"		POZIDRIV INSERT	25	\$0.90
PZ-025-02	#2 X 1"		POZIDRIV INSERT	25	\$0.90
PZ-025-03	#3 X 1"		POZIDRIV INSERT	25	\$0.90



**Pozidriv® Power Bits - 1/4" Hex Shank**

Part #	Size	OAL	Type	Qty.	List
PZ-050-01	#1 X 2"		POZIDRIV POWER	25	\$1.40
PZ-050-02	#2 X 2"		POZIDRIV POWER	25	\$1.40
PZ-075-02	#2 X 3"		POZIDRIV POWER	25	\$1.90
PZ-050-03	#3 X 2"		POZIDRIV POWER	25	\$1.40



**Slotted Insert Bits - 1/4" Hex Shank**

Part #	Size	OAL	Type	Qty.	List
ST-025-04	#4-5 X 1"		SLOTTED INSERT	25	\$0.56
ST-025-08	#6-8 X 1"		SLOTTED INSERT	25	\$0.56
ST-025-10	#8-10 X 1"		SLOTTED INSERT	25	\$0.56
ST-025-12	#10-12 X 1"		SLOTTED INSERT	25	\$0.56



**Slotted Power Bits - 1/4" Hex Shank**

Part #	Size	OAL	Type	Qty.	List
ST-050-04	#4-5 X 2"		SLOTTED POWER	25	\$0.98
ST-050-08	#6-8 X 2"		SLOTTED POWER	25	\$0.98
ST-050-10	#8-10 X 2"		SLOTTED POWER	25	\$0.98
ST-070-10	#8-10 X 3"		SLOTTED POWER	25	\$1.48
ST-090-10	#8-10 X 3-1/2"		SLOTTED POWER	25	\$1.65
ST-050-12	#10-12 X 2"		SLOTTED POWER	25	\$0.98



**Hex Insert Bits - 1/4" Hex Shank**

Part #	Size	OAL	Type	Qty.	List
HE-25-564	5/64" X 1"		HEX INSERT	25	\$0.80
HE-25-332	3/32" X 1"		HEX INSERT	25	\$0.80
HE-25-764	7/64" X 1"		HEX INSERT	25	\$0.80
HE-25-864	1/8" X 1"		HEX INSERT	25	\$0.80
HE-25-532	5/32" X 1"		HEX INSERT	25	\$0.80
HE-25-316	3/16" X 1"		HEX INSERT	25	\$0.80



**Hex Insert Bits - 5/16" Hex Shank**

Part #	Size	OAL	Type	Qty.	List
HE-32-316	3/16" X 1-1/4"		HEX INSERT	25	\$1.46
HE-32-732	7/32" X 1-1/4"		HEX INSERT	25	\$1.46
HE-32-014	1/4" X 1-1/4"		HEX INSERT	25	\$1.46



**Double End Bits - 1/4" Hex Shank**

Part #	Size	Qty.	List
DW-050-22	#2 PHILLIPS / #2 PHILLIPS	25	\$1.52
DW-050-26	#2 PHILLIPS / #6-8 SLOTTED	25	\$1.52
DW-050-28	#2 PHILLIPS / #8-10 SLOTTED	25	\$1.52



- ◆ S2 Modified Steel
- ◆ Rc. 58-62 Heat Treated
- ◆ German Grade Steel



### Spanner Insert Bits - 1/4" Hex Shank

Part #	Size	OAL	Type	Qty.	List
SP-025-06	#6 X 1"		SPANNER	25	\$1.75
SP-025-08	#8 X 1"		SPANNER	25	\$1.75
SP-025-10	#10 X 1"		SPANNER	25	\$1.75
SP-025-12	#12 X 1"		SPANNER	25	\$1.75
SP-025-14	#14 X 1"		SPANNER	25	\$1.75



### Hex Tamper Insert Bits - 1/4" Hex

Part #	Size	OAL	Type	Qty.	List
TH-25-332	3/32" X 1"		HEX TAMPER	25	\$1.55
TH-25-018	1/8" X 1"		HEX TAMPER	25	\$1.55
TH-25-964	9/64" X 1"		HEX TAMPER	25	\$1.55
TH-25-532	5/32" X 1"		HEX TAMPER	25	\$1.55
TH-25-316	3/16" X 1"		HEX TAMPER	25	\$1.55
TH-25-732	7/32" X 1"		HEX TAMPER	25	\$1.55
TH-25-014	1/4" X 1"		HEX TAMPER	25	\$1.55
TH-25-516	5/16" X 1"		HEX TAMPER	25	\$1.55



For TAMPER RESISTANT Torx® Screws

### Star Tamper Insert Bits - 1/4" Hex

Part #	Size	OAL	Type	Qty.	List
TT-025-08	T8 X 1"		STAR TAMPER	25	\$1.45
TT-025-09	T9 X 1"		STAR TAMPER	25	\$1.45
TT-025-10	T10 X 1"		STAR TAMPER	25	\$1.45
TT-025-15	T15 X 1"		STAR TAMPER	25	\$1.45
TT-025-20	T20 X 1"		STAR TAMPER	25	\$1.45
TT-025-25	T25 X 1"		STAR TAMPER	25	\$1.45
TT-025-27	T27 X 1"		STAR TAMPER	25	\$1.45
TT-025-30	T30 X 1"		STAR TAMPER	25	\$1.45
TT-025-40	T40 X 1"		STAR TAMPER	25	\$1.45

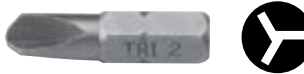

### Tri-Wing® Tamper Insert Bits - 1/4" Hex

Part #	Size	OAL	Type	Qty.	List
TRI-25-01	#1 X 1"		TRI-WING	25	\$1.68
TRI-25-02	#2 X 1"		TRI-WING	25	\$1.68
TRI-25-03	#3 X 1"		TRI-WING	25	\$1.68



For TAMPER RESISTANT Torx® Screws

### Star Tamper Insert Bits - 5/16" Hex

Part #	Size	OAL	Type	Qty.	List
TT-032-45	T45 X 1-1/4"		STAR TAMPER	25	\$2.80
TT-032-50	T50 X 1-1/4"		STAR TAMPER	25	\$2.80
TT-032-55	T55 X 1-1/4"		STAR TAMPER	25	\$2.80



### Phillips® Tamper Insert Bits - 1/4" Hex

Part #	Size	OAL	Type	Qty.	List
TP-025-02	#2 X 1"		PHILLIPS TAMPER	25	\$2.75
TP-025-03	#3 X 1"		PHILLIPS TAMPER	25	\$2.75



- ◆ S2 Modified Steel
- ◆ Rc. 58-62 Heat Treated
- ◆ German Grade Steel

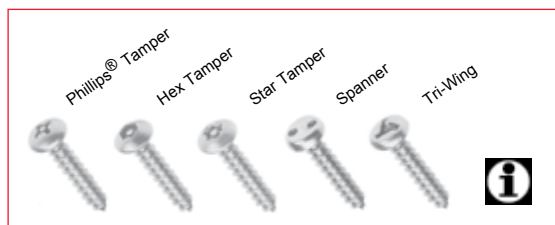





## Bit Holders - Stainless Steel - Magnetic



Part #	OAL	Body Dia.	Retaining Ring	Description	List
BH-020-RC	1-3/4"	7/16"	NO	2PC. CONSTRUCTION	\$5.33



Part #	OAL	Body Dia.	Retaining Ring	Description	List
BH-040-RC	1-13/16"	7/16"	YES	1PC. CONSTRUCTION	\$5.65



Part #	OAL	Body Dia.	Retaining Ring	Description	List
BH-060-RC	2-5/8"	7/16"	YES	1PC. CONSTRUCTION	\$4.75

BH-060-40 made of Chrome Vanadium.



Part #	OAL	Body Dia.	Retaining Ring	Description	List
BH-060-40	2-5/8"	3/8"	NO	2PC. CONSTRUCTION	\$3.21



Part #	OAL	Body Dia.	Retaining Ring	Description	List
BH-075-14	3"	7/16"	NO	2PC. CONSTRUCTION	\$4.77



Part #	OAL	Body Dia.	Retaining Ring	Description	List
BH-075-14R	3"	7/16"	YES	2PC. CONSTRUCTION	\$5.00



Part #	OAL	Body Dia.	Retaining Ring	Description	List
BH-075-RC	3"	7/16"	YES	1PC. CONSTRUCTION	\$5.35



Part #	OAL	Body Dia.	Retaining Ring	Description	List
BH-100-TR	3"	7/16"	THREADED	1PC. CONSTRUCTION	\$10.80



Part #	OAL	Body Dia.	Retaining Ring	Description	List
BH-100-RC	4"	7/16"	YES	1PC. CONSTRUCTION	\$8.83



Part #	OAL	Body Dia.	Retaining Ring	Description	List
BH-150-RC	6"	7/16"	YES	1PC. CONSTRUCTION	\$16.93

## Bit Holders - Special Application - Magnetic

Part #	OAL	Body Dia.	Retaining Ring	Description	List
BH-050-LK	2"	9/16"	YES / LOCK	SNAP LOCK HOLDER	\$7.18
BH-075-LK	3"	9/16"	YES / LOCK	SNAP LOCK HOLDER	\$9.63



Pull back system locks in bits.

Part #	OAL	Body Dia.	Retaining Ring	Description	List
BH-075-SL	3"	7/16"	NO	SLEEVE GUIDE HOLDER	\$5.72
BH-125-SL	5"	7/16"	NO	SLEEVE GUIDE HOLDER	\$6.05



Sleeve extends up to 8" (on 5" length sleeve guide) to hold screw while fasteneing.

Part #	OAL	Body Dia.	Retaining Ring	Description	List
FX-075-01	7-1/4"	1/2"	YES / BALL	FLEXIBLE BIT HOLDER	\$13.75



Flexible shaft can bend up to 90° for those hard to reach areas.

Part #	OAL	Body Dia.	Retaining Ring	Description	List
QUI0001	1-3/4"	13/16"	LOCK	METAL/SPRING OUT	\$6.25



Chucks have a quick insert / quick spring out system for easy bit changing. Locks in bits. Use with 2"+ POWER bits only!!!

Part #	OAL	Body Dia.	Retaining Ring	Description	List
DC-075-01	3"	9/16"	LOCK	POWER STOPPER	\$9.95



Use with any 1" bit tips. Adjustable depth prevents over-driving screws into material. Magnetic.

## Lag Driver / Ceiling Tile Hanger Driver

Part #	Size	Type	Qty.	List
CE-075-14SL	7/16" X 2-3/16"	LAG DRIVER WITH SLEEVE	10	\$3.95





1/4"  
DRIVE

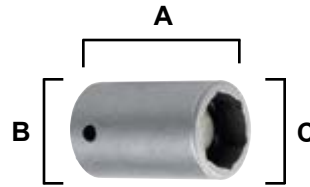

### 1/4" Square Drive Extension

Part #	OAL	List
AD-025-14	1"	\$2.88
AD-032-14	1-1/4"	\$4.22
AD-050-14	2"	\$4.25
AD-075-14	3"	\$4.66
AD-100-14	4"	\$5.90
AD-150-14	5"	\$7.42
AD-200-14	6"	\$9.09

### 1/4" Square Drive Impact Sockets

Part #	Hex Size	Length (A)	Body (B)	Nose (C)	List
250ST1264	3/16"	15/16"	1/2"	3/8"	\$6.60
250ST1664	1/4"	15/16"	1/2"	7/16"	\$6.89
250ST2064	5/16"	15/16"	1/2"	1/2"	\$7.66
250ST2464	3/8"	1"	5/8"	9/16"	\$7.89
250ST3264	1/2"	1"	3/4"	3/4"	\$9.59



3/8"  
DRIVE

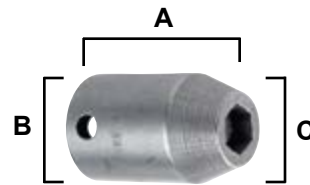

### 3/8" Square Drive Extension

Part #	OAL	List
AD-050-38	2"	\$6.01
AD-075-38	3"	\$6.45
AD-100-38	4"	\$8.95
AD-150-38	6"	\$11.00
AD-200-38	8"	\$16.25

### 3/8" Square Drive Impact Sockets

Part #	Hex Size	Length (A)	Body (B)	Nose (C)	List
375ST1664	1/4"	1-1/4"	3/4"	7/16"	\$7.74
375ST2064	5/16"	1-1/4"	3/4"	1/2"	\$7.74
375ST2464	3/8"	1-1/4"	3/4"	9/16"	\$8.65
375ST3264	1/2"	1-1/2"	15/16"	3/4"	\$11.73



1/2"  
DRIVE

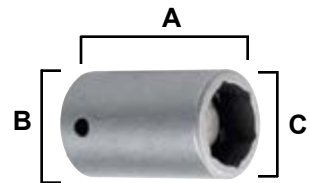

### 1/2" Square Drive Extension

Part #	OAL	List
AD-055-12	2-1/8"	\$7.13
AD-075-12	3"	\$8.69
AD-150-12	6"	\$12.39
AD-200-12	8"	\$16.48

### 1/2" Square Drive Impact Sockets

Part #	Hex Size	Length (A)	Body (B)	Nose (C)	List
500ST1664	1/4"	1-1/2"	15/16"	7/16"	\$9.59
500ST2064	5/16"	1-1/2"	15/16"	1/2"	\$9.03
500ST2464	3/8"	1-1/2"	15/16"	9/16"	\$9.24
500ST3264	1/2"	1-1/2"	15/16"	3/4"	\$10.15

## Nut Setters - Magnetic Impact Protection

Part #	Hex Head Size	X	OAL	Type	Qty.	List
IMP-042-16	1/4"	X	1-3/4"	MAG. IMPACT	10	\$3.60
IMP-065-16	1/4"	X	2-9/16"	MAG. IMPACT	10	\$4.31
IMP-075-16	1/4"	X	4"	MAG. IMPACT	5	\$10.01
IMP-085-16	1/4"	X	6"	MAG. IMPACT	5	\$13.60
IMP-042-20	5/16"	X	1-3/4"	MAG. IMPACT	10	\$4.03
IMP-065-20	5/16"	X	2-9/16"	MAG. IMPACT	10	\$5.69
IMP-075-20	5/16"	X	4"	MAG. IMPACT	5	\$12.01
IMP-085-20	5/16"	X	6"	MAG. IMPACT	5	\$18.16
IMP-042-24	3/8"	X	1-3/4"	MAG. IMPACT	10	\$4.58
IMP-065-24	3/8"	X	2-9/16"	MAG. IMPACT	10	\$6.81
IMP-075-24	3/8"	X	4"	MAG. IMPACT	5	\$13.77
IMP-085-24	3/8"	X	6"	MAG. IMPACT	5	\$22.98
IMP-085-40	9/16"	X	6"	MAG. IMPACT	5	\$25.27

## Nut Setters - Magnetic (Standard)

Part #	Hex Head Size	X	OAL	Type	Qty.	List
NS-042-16	1/4"	X	1-3/4"	MAG. NUT SETTER	10	\$2.40
NS-053-16	1/4"	X	2-1/8"	MAG. NUT SETTER	10	\$2.75
NS-065-16	1/4"	X	2-9/16"	MAG. NUT SETTER	10	\$2.89
NS-075-16	1/4"	X	4"	MAG. NUT SETTER	5	\$8.70
NS-085-16	1/4"	X	6"	MAG. NUT SETTER	5	\$11.83
NS-042-20	5/16"	X	1-3/4"	MAG. NUT SETTER	10	\$2.55
NS-053-20	5/16"	X	2-1/8"	MAG. NUT SETTER	10	\$3.05
NS-065-20	5/16"	X	2-9/16"	MAG. NUT SETTER	10	\$3.25
NS-075-20	5/16"	X	4"	MAG. NUT SETTER	5	\$10.44
NS-085-20	5/16"	X	6"	MAG. NUT SETTER	5	\$15.79
NS-042-24	3/8"	X	1-3/4"	MAG. NUT SETTER	10	\$3.25
NS-053-24	3/8"	X	2-1/8"	MAG. NUT SETTER	10	\$4.25
NS-065-24	3/8"	X	2-9/16"	MAG. NUT SETTER	10	\$4.65
NS-075-24	3/8"	X	4"	MAG. NUT SETTER	5	\$11.97
NS-085-24	3/8"	X	6"	MAG. NUT SETTER	5	\$19.98
NS-042-28	7/16"	X	1-3/4"	MAG. NUT SETTER	5	\$6.75
NS-053-28	7/16"	X	2-1/8"	MAG. NUT SETTER	5	\$7.56
NS-065-28	7/16"	X	2-9/16"	MAG. NUT SETTER	5	\$7.99
NS-042-32	1/2"	X	1-3/4"	MAG. NUT SETTER	5	\$7.45
NS-065-32	1/2"	X	2-9/16"	MAG. NUT SETTER	5	\$8.65



- ◆ Made for Powerful Impact Drivers / Wrenches
- ◆ 1pc Construction
- ◆ Industrial Grade Magnet
- ◆ 1/4" Hex Power Shank



**IMPACT**  
1/4" HEX IMPACT SHANK



MAGNETIC



1-3/4" Long



2-9/16" Long



4" Long



- ◆ 1pc Construction
- ◆ Industrial Grade Magnet
- ◆ 1/4" Hex Power Shank



1-3/4" Long



2-1/8" Long



2-9/16" Long



4" Long

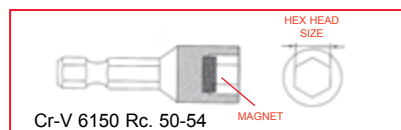

**COMES WITH CASE AND HANDLE!**



### 30 Pc. Screwdriver Insert Set - STANDARD

Part #	Description	List
ST-100-30	<ul style="list-style-type: none"> <li>⊕ <b>Phillips:</b> #1, #2, #3</li> <li>⊖ <b>Slotted:</b> 3-4, 4-5, 6-8, 8-10</li> <li>⊕ <b>Posidriv:</b> #1, #2, #3</li> <li>⊖ <b>Square:</b> #0, #1, #2, #3</li> <li>⊖ <b>Hex:</b> 5/64", 3/32", 7/64", 1/8", 9/64"</li> <li>⊖ <b>Star:</b> T10, T15, T20, T25, T27, T30, T40</li> <li>● <b>1" Long Socket Adaptor</b></li> <li>● <b>3" Long Bit Holder</b></li> </ul>	\$41.64

**COMES WITH CASE AND HANDLE!**



### 30 Pc. Screwdriver Insert Set - TAMPER PROOF

Part #	Description	List
TR-100-30	<ul style="list-style-type: none"> <li>⊕ <b>Spanner:</b> #6, #8, #10</li> <li>⊕ <b>Posidriv:</b> #1, #2, #3</li> <li>⊖ <b>Tri-Wing:</b> #1, #2, #3</li> <li>⊖ <b>Hex Tamper:</b> 3/32", 1/8", 9/64", 5/32", 3/16", 7/32", 1/4", 5/16"</li> <li>⊖ <b>Star Tamper:</b> T8, T9, T10, T15, T20, T25, T27, T30, T40</li> <li>● <b>1" Long Socket Adaptor</b></li> <li>● <b>3" Long Bit Holder</b></li> </ul>	\$52.25



### 32 Pc. Screwdriver Insert Set - STANDARD

Part #	Description	List
TECH-32	<ul style="list-style-type: none"> <li>⊕ <b>Phillips:</b> #0, #1, #2 (2), #3, #2DW (2)</li> <li>⊖ <b>Slotted:</b> 6-8, 8-10, 10-12</li> <li>⊖ <b>Square:</b> #0, #1, #2 (3), #3</li> <li>⊖ <b>Hex:</b> 5/64", 3/32", 7/64", 1/8", 5/32", 3/16"</li> <li>⊖ <b>Star:</b> T8, T10, T15, T20, T25, T27, T30, T40</li> <li>● <b>1/4" Impact Driver Adaptor</b></li> <li>● <b>1/4" Auto Locking Magnetic Bit Holder</b></li> </ul>	\$40.79



← Belt Clip



### 32 Pc. Screwdriver Insert Set - TAMPER PROOF

Part #	Description	List
TECH-32TR	<ul style="list-style-type: none"> <li>⊕ <b>Spanner:</b> #6, #8, #10, #12, #14</li> <li>⊖ <b>Star Tamper:</b> T8, T9, T10, T15, T20, T25, T27, T30, T40</li> <li>⊖ <b>Hex Tamper:</b> 3/32", 1/8", 9/64", 5/32", 3/16", 7/32", 1/4", 5/16"</li> <li>⊖ <b>Tri-Wing:</b> #1, #2, #3</li> <li>⊖ <b>Square:</b> #1, #2, #3</li> <li>⊕ <b>Phillips:</b> #2, #3</li> <li>● <b>1/4" Impact Driver Adaptor</b></li> <li>● <b>1/4" Auto Locking Magnetic Bit Holder</b></li> </ul>	\$48.12

US PATENT 5265504

Made In

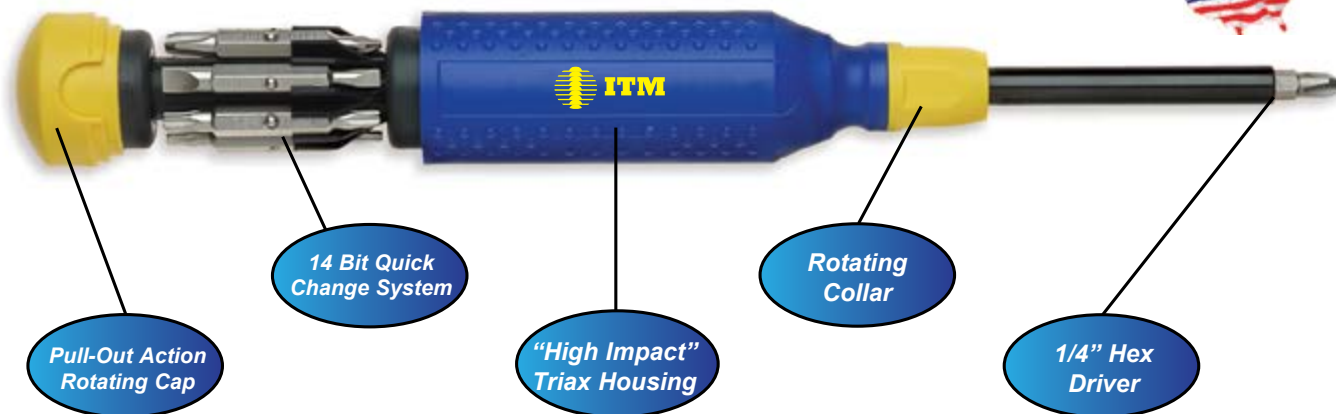

Part #	Description	List
MEGAPRO151	<b>15-IN-1 MEGAPRO SCREWDRIVER</b> #0 - #3 PHILLIPS #10 - #15 STAR #1 - #2 PHILLIPS #20 - #25 STAR #0 - #3 SQUARE #4 - #6 SLOTTED #1 - #2 SQUARE	\$41.19



Part #	Description	List
MEGATAM151	<b>15-IN-1 TAMPERPROOF SCREWDRIVER</b> #6 - #8 SPANNER #10 - #15 STAR PIN #10 - #12 SPANNER #20 - #25 STAR PIN 1/8" - 9/64" HEX PIN #27 - #30 STAR PIN 5/32" - 3/16" HEX PIN	\$52.47



**Tamper Proof** Tamper Proof Driver sold Individually Tubed.

Part #	Description	List
470001	#0 - #3 PHILLIPS®	\$2.50
470002	#1 - #2 PHILLIPS®	\$2.50
470003	#0 - #3 SQUARE	\$2.50
470004	#1 - #2 SQUARE	\$2.50
470005	#10 - #15 STAR	\$2.50
470006	#20 - #25 STAR	\$2.50
470009	#27 - #30 STAR (SPECIAL SIZE)	\$2.50
470007	#4 - #6 SLOTTED	\$2.50
690001	#6 - #8 SPANNER	\$2.75
690002	#10 - #12 SPANNER	\$2.75
690003	1/8" - 9/64" HEX PIN	\$2.75
690004	5/32" - 3/16" HEX PIN	\$2.75
690005	#10 - #15 STAR PIN	\$2.75
690006	#20 - #25 STAR PIN	\$2.75
690007	#27 - #30 STAR PIN	\$2.75

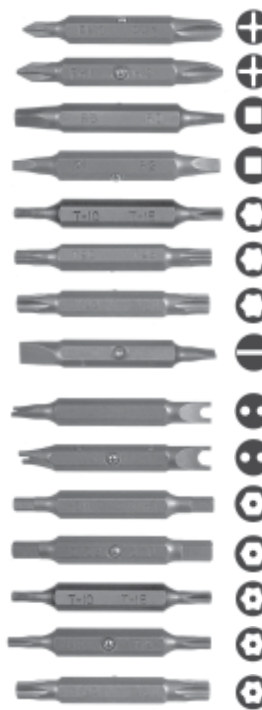

Replacement bits for the Megapro & Megapro Tamper Proof are sold individually.

PHILLIPS® IS A REGISTERED TRADEMARK OF PHILLIPS SCREW CO.



- ◆ Manufactured of 100% Nylon
- ◆ Non-Corrosive
- ◆ Specification: Type 6.6 Nylon
- ◆ Self-Extinguishing
- ◆ Natural & Weather Resistant Black Operating Temperatures From 40° F (-40° C) to 185° F (85° C).
- ◆ Recognized Under the Components Program of Underwriter Laboratories, Inc.

File # E 57800.

**NATURAL NYLON 6.6 CABLE TIES**

Part #	Length	Tensile Strength	Width	Bundle Diameter	Military Specification	Pack Qty.	List / 100
MS0016-C	4"	18 lbs.	3/32"	1/16" → 5/8"	MS-3367-4-9	100	\$4.18
MS0032-C	5.5"	40 lbs.	1/8"	1/16" → 1-1/4"	MS-3367-5-9	100	\$5.22
MS0050-C	8"	50 lbs.	1/8"	1/16" → 2-1/8"	MS-3367-1-9	100	\$6.32
MS0070-C	11"	50 lbs.	3/16"	1/16" → 3"	MS-3367-7-9	100	\$13.92
MS0108-C	15"	50 lbs.	3/16"	1/16" → 4"	MS-3367-2-9	100	\$19.14

**NATURAL NYLON 6.6 CABLE TIES - EXTRA HEAVY DUTY**

Part #	Length	Tensile Strength	Width	Bundle Diameter	Military Specification	Pack Qty.	List / 100
XMS0050	8"	120 lbs.	5/16"	3/16" → 2"	-	100	\$17.69
XMS0070	11"	120 lbs.	5/16"	3/16" → 3"	-	100	\$19.67
XMS0108	15"	120 lbs.	5/16"	3/16" → 4"	-	100	\$22.74
XMS0152	24"	175 lbs.	3/8"	3/16" → 7"	-	100	\$41.45
XMS0225	36"	175 lbs.	3/8"	3/16" → 10"	-	100	\$48.02
XMS0300	48"	175 lbs.	3/8"	3/16" → 12"	-	100	\$71.94

**BLACK WEATHER RESISTANT NYLON CABLE TIES**

Part #	Length	Tensile Strength	Width	Bundle Diameter	Military Specification	Pack Qty.	List / 100
BWR0016-C	4"	18 lbs.	3/32"	1/16" → 5/8"	MS-3367-4-0	100	\$5.02
BWR0032-C	5.5"	40 lbs.	1/8"	1/16" → 1-1/4"	MS-3367-5-0	100	\$6.26
BWR0050-C	8"	50 lbs.	1/8"	1/16" → 2-1/8"	MS-3367-1-0	100	\$7.58
BWR0070-C	11"	50 lbs.	3/16"	1/16" → 3"	MS-3367-7-0	100	\$14.99
BWR0108-C	15"	50 lbs.	3/16"	1/16" → 4"	MS-3367-2-0	100	\$20.69

**BLACK WEATHER RESISTANT NYLON CABLE TIES - EXTRA H.D.**

Part #	Length	Tensile Strength	Width	Bundle Diameter	Military Specification	Pack Qty.	List / 100
XBWR050	8"	120 lbs.	5/16"	3/16" → 2"	-	100	\$17.99
XBWR070	11"	120 lbs.	5/16"	3/16" → 3"	-	100	\$20.27
XBWR108	15"	120 lbs.	5/16"	3/16" → 4"	-	100	\$25.72
XBWR152	24"	175 lbs.	3/8"	3/16" → 7"	-	100	\$45.15
XBWR225	36"	175 lbs.	3/8"	3/16" → 10"	-	100	\$56.60
XBWR300	48"	175 lbs.	3/8"	3/16" → 12"	-	100	\$85.19

**CABLE TIE WITH SCREW MOUNT HOLE**

Part #	Length	Tensile Strength	Width	Bundle Diameter	Military Specification	Pack Qty.	List / 100
<b>NATURAL</b>							
WCM0050	8"	50 lbs.	1/8"	1/16" → 2-1/8"	-	100	\$8.89
WCM0070	11"	50 lbs.	3/16"	1/16" → 3"	-	100	\$16.90
WCM0108	14"	50 lbs.	3/16"	1/16" → 4"	-	100	\$17.80
<b>BLACK</b>							
BCM0050	8"	50 lbs.	1/8"	1/16" → 2-1/8"	-	100	\$8.89
BCM0070	11"	50 lbs.	3/16"	1/16" → 3"	-	100	\$16.90
BCM0108	14"	50 lbs.	3/16"	1/16" → 4"	-	100	\$17.80



CONICAL ANCHOR - BLUE

<b>PART# 807AK0010</b>	
100 pcs.	- 3/16" Conical Anchors
100 pcs.	- #8 Combo Screws
1 pc.	- 3/16" Slow Spiral Masonry
<b>List</b>	<b>\$7.65</b>



RIBBED ANCHOR - GREY

<b>PART# 807AK0006</b>	
100 pcs.	- 3/16" Ribbed Anchors
100 pcs.	- #8 Combo Screws
1 pc.	- 3/16" Slow Spiral Masonry
<b>List</b>	<b>\$8.57</b>



SUPER ANCHOR - YELLOW

<b>PART# SUPRAK006</b>	
100 pcs.	- 3/16" SUPER Anchors
100 pcs.	- #8 Combo Screws
1 pc.	- 3/16" Slow Spiral Masonry
<b>List</b>	<b>\$8.52</b>



ZAP-IN ANCHOR

<b>PART# EZZ-PACK</b>	
50 pcs.	- Zinc Zap-In
50 pcs.	- #8 x 1" Combo Screws
1 pc.	- #2 X 2" Phillips Bit
<b>List</b>	<b>\$25.46</b>

<b>PART# 807AK0011</b>	
100 pcs.	- 1/4" Conical Anchors
100 pcs.	- #10 Combo Screws
1 pc.	- 1/4" Slow Spiral Masonry
<b>List</b>	<b>\$9.58</b>

<b>PART# 807AK0016</b>	
100 pcs.	- 1/4" Ribbed Anchors
100 pcs.	- #10 Combo Screws
1 pc.	- 1/4" Slow Spiral Masonry
<b>List</b>	<b>\$9.58</b>

<b>PART# SUPRAK008</b>	
100 pcs.	- 1/4" SUPER Anchors
100 pcs.	- #10 x 1 1/2" Combo Screws
1 pc.	- 1/4" Slow Spiral Masonry
<b>List</b>	<b>\$11.20</b>

<b>PART# 807AK0013</b>	
50 pcs.	- 5/16" Conical Anchors
50 pcs.	- #12 Combo Screws
1 pc.	- 5/16" Slow Spiral Masonry
<b>List</b>	<b>\$11.56</b>

<b>PART# 807AK0009</b>	
50 pcs.	- 5/16" Ribbed Anchors
50 pcs.	- #12 Combo Screws
1 pc.	- 5/16" Slow Spiral Masonry
<b>List</b>	<b>\$11.56</b>

<b>PART# SUPRAK009</b>	
50 pcs.	- 5/16" SUPER Anchors
50 pcs.	- #12 x 1 1/2" Combo Screws
1 pc.	- 5/16" Slow Spiral Masonry
<b>List</b>	<b>\$11.57</b>



COMBO SCREW

## Anchor Kits



## ZAP-IN Anchors - Zamac Alloy

Part #	OAL	Description	Box Qty.	Packaged	List / C
EZZ1212	1-5/16"	ZAP IN ZAMAC ALLOY	100	BOX	\$42.19
EZZ1212B	1-5/16"	ZAP IN ZAMAC ALLOY	2,000	BULK	\$36.36

- ◆ Industrial Quality
- ◆ Ideal for Fastening to Drywall and Other Low Density Substrates
- ◆ Easily Removable by Simply Backing Out Screw



## Hammer Drive Nail-In Anchors - Zamac

Part #	Size	Description	Drill	Box Qty.	List / C
HD14340	1/4" X 3/4"	MUSHROOM	1/4"	100	\$23.67
HD14010	1/4" X 1"	MUSHROOM	1/4"	100	\$26.17
HD14114	1/4" X 1-1/4"	MUSHROOM	1/4"	100	\$30.00
HD14112	1/4" X 1-1/2"	MUSHROOM	1/4"	100	\$33.33
HD14200	1/4" X 2"	MUSHROOM	1/4"	100	\$38.33

Meets or exceeds GSA Specification FF-S-325, Group V, Type 2, Class 3.

### EASY TO INSTALL

No screws necessary. Just drill 1/4" hole and hammer in the anchor.

- Hollow Wall
- Solid Wall
- Concrete
- Stone
- Brick
- Plaster
- Sheet Metal



## Split Drive Anchors - Zinc Plated

Part #	Size	Minimum Embedment	Drill	Box Qty.	List / C
FDA14150	1/4" X 1-1/2"	1-1/8"	1/4"	100	\$18.89
FDA14200	1/4" X 2"	1-1/8"	1/4"	100	\$26.04
FDA14250	1/4" X 2-1/2"	1-1/8"	1/4"	100	\$26.39
FDA14300	1/4" X 3"	1-1/8"	1/4"	100	\$34.17
FDA14350	1/4" X 3-1/2"	1-1/8"	1/4"	100	\$41.67
FDA14400	1/4" X 4"	1-1/8"	1/4"	100	\$47.15

Meets or exceeds GSA Specification FF-S-325, Group IV.

### EASY TO INSTALL

No screws necessary. Just drill 1/4" hole and hammer in the anchor.

- ◆ Carbon Steel Construction
- ◆ Flat Head
- Concrete
- Stone
- Solid Brick





- ◆ Retractable 3 Blade Positions
- ◆ Extra Blade Inside Compartment
- ◆ Carded and Sold Individually



### Carded Utility Knife - 1 Pack

Part #	Description	List
UTK0001	UTILITY KNIFE	\$6.95

- ◆ Retractable 3 Blade Positions
- ◆ 3 Blades In Each Knife
- ◆ Heavy Duty Die Cast Aluminum
- ◆ Pull Out Mechanism For Quick Blade Change

FREE COUNTER DISPLAY WITH EVERY ORDER.



### Quick Release Utility Knife - 12 Pack

Part #	Description	List
UTK0002	UTILITY KNIFE (12 PK)	\$12.50/ea

- ◆ Double Sided Tooth Geometry
- ◆ Narrow Blade Ideal For Awkward Cuts
- ◆ Carded And Sold Individually



- ◆ 6 in 1 Quick Change
- ◆ Industrial Quality

SOLD IN 12 PIECE DISPLAY BOX ONLY.



### 6" Wallboard Saw - 1 Pack

Part #	Description	List
WS-6	6" WALLBOARD SAW	\$6.40

### 6-IN-1 Combination Screwdriver

Part #	Description	List
ST-100-20	6-IN-1 SCREWDRIVER #1, #2, PHILLIPS 1/4" NUT SETTER #5, #8-10, SLOTTED 5/16" NUT SETTER	\$7.25/ea

- ◆ Heavy Duty
- ◆ Fits All Standard Knives
- ◆ Made in Taiwan



### Heavy Duty Utility Blades

Part #	Description	Qty.	List
HDB9005	INDIVIDUAL PACK	5	\$1.95
HDB9100	100 PACK (20 X 5 PACKS)	100	\$25.24

### Dust Masks / Safety Goggles

Part #	Description	Qty.	List
MSK55	SINGLE STRAP	5	\$2.80
GOG0001	SAFETY GOGGLES	1	\$4.15